

How to use (Mobile Antenna)

1. Connect it as shown in below.
2. Plugging the cigarette lighter plug into a cigarette socket and turning the power/gain control knob, the product is on. The preamplifier is in use. (Don't use it for 24V car) (LED ON)
3. After receiving the signal you want to listen, adjust the gain control knob ① depending on incoming signal strength to have good sound quality.

4. To use the product by passing through the amplifier, turn the gain control knob extreme counter clockwise to turn the product off.

※ At the moment when the product is turned off, the gain of the product returns to 0dB from minus level. And AF gain may be boosted.

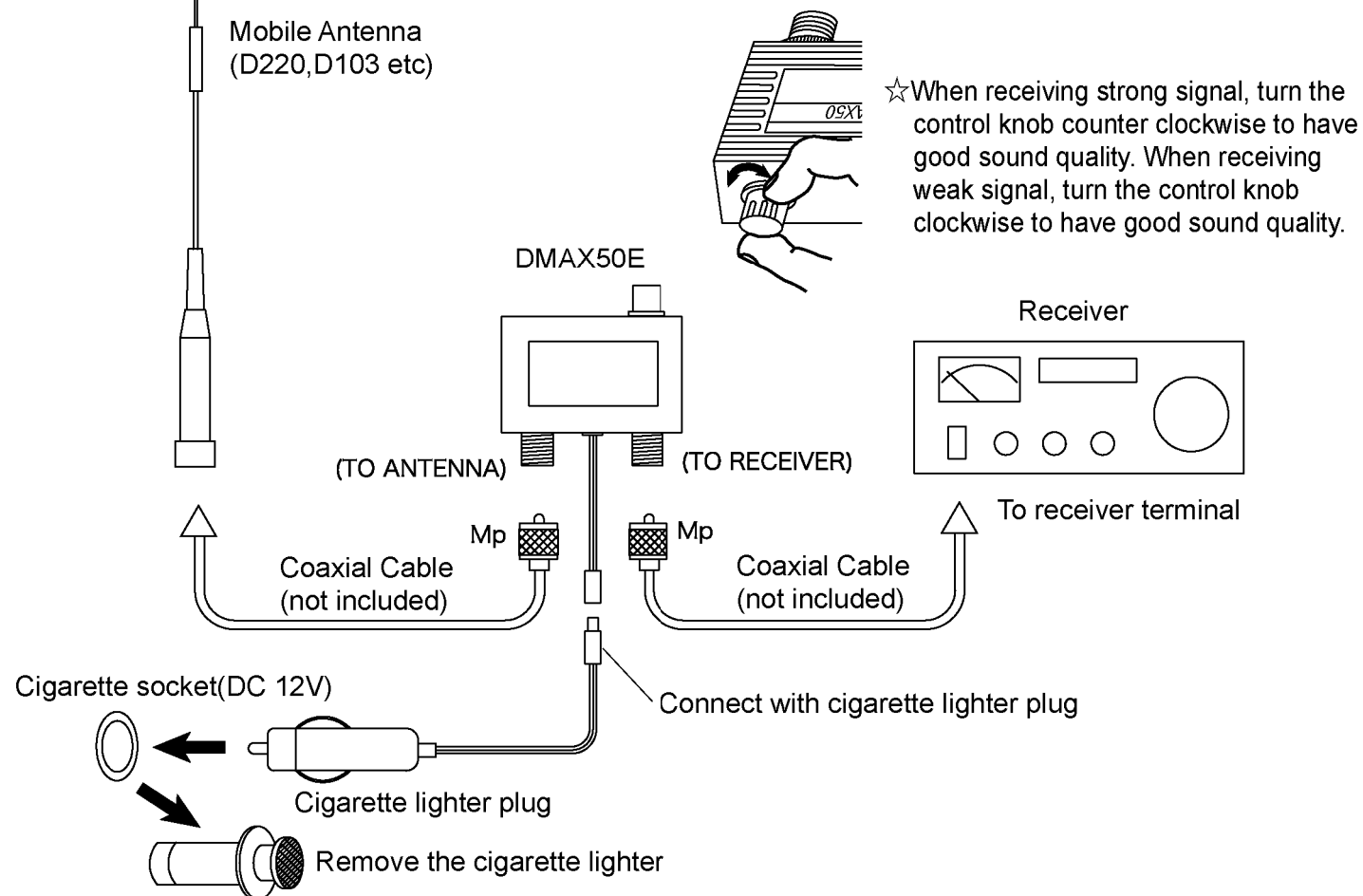

※ Attach the rubber cushions on the bottom of the preamplifier if you like. Set the preamplifier on the place where you can operate conveniently.

Recommend Antennas (Diamond Antenna Products)

(Fixed Station Antennas)

Discone antennas - D130, D1300AM, D150, D190

Wide band dipole antenna - WD330, WD330S

Other - D303, D777

(Mobile Antennas)

Discone antenna - D220

Other - D103, NR950M

■ Though the product being purchased is manufactured under strict quality control, if damage is caused by transporting, ask your dealer promptly.

■ Design and specification of these products will be changed for future improvement without advance notice.

Troubleshooting

1. No sound from the receiver

The antenna and the preamplifier are connected with the cable correctly?

The preamplifier and the receiver are connected with the coaxial cable correctly? The impedance of the antenna connected is 50Ω.

The power is supplied?

2. The sound is distorted.

Turn the power/gain control knob counter clockwise to have good sound quality. In case of the strong radio wave, don't have high gain. Use the product by passing through the amplifier (power off).

3. Output sound is too low.

Turn the control knob clockwise to have good sound quality.

0.5-1500MHz Preamplifier for Wide Band Receiving Antenna

DMAX50E

DIAMOND
ANTENNA

Operation Instructions

DMAX50E is a preamplifier for wide band receiving antenna. It is designed as high gain and low noise.

To use the preamplifier properly, read these instructions thoroughly before using it. Keep this manual carefully at hand for later use. The manual will be changed in the future without advance notice

Warning

- Do not use the product under unusual conditions. Do not use the product when unusual conditions happen such as smoking, unusual smell or sound. Keeping using the product may cause to electrify or damage. Immediately cut off power supply. Ask the dealer to repair it. Do not repair it by yourself because it is dangerous.
- Do not overhaul or reconstruct the product. It may cause to have a fire, electrify or damage.
- Do not put wire, metal or substance into the product. It may cause to have a fire, electrify or damage.
- Do not use the product at the place where inflammability gas is generated. It may cause to have a fire or explode.
- Do not use the product except for the specification of the operation instructions. It may cause to have a fire, or electrify
- Do not damage, process, bend, twist or put the power supply cord. Do not put something heavy on the product or heat it up. Breaking the cord may cause

to have a fire, electrify or damage.

- Do not use the product when cigarette lighter is inserted loosely. It may cause to have a fire, electrify or damage.
- Do not touch power supply plug or the product with wet hands.
- Do not use the product where is easily reachable by babies and children. It may cause to electrify or do themselves an injury.
- Do not soak the product in water. Do not get wet the product. It may cause to have a fire, electrify or damage.
- Do not drop the product. Do not give them big impact.

Attention

- Do not install the product where is got the direct rays of the sun. Do not install the product near the jet of the air conditioner. It may cause to have a fire, transform, discolor or damage.
- Do not wipe it off with thinner or benzene. If it becomes too dirty, wipe it off with neuter detergent.
- Do not install the product where there are mush moisture or dust. It may cause to have a fire, generate heat, electrify or damage.
- For the safety, be sure to cut off the power supply when it is not used.
- Do not put something heavy on the product.
- Use the product under rated specification only.
- Don't use the product when driving a car. Serious accidents could have been happened.

DIAMOND ANTENNA CORPORATION

Miyata Building, No.15-1, 1-chome, Sugamo Toshima-ku, Tokyo 170-0002, Japan Phone:(03) 3947-1411 Fax:(03) 3944-2981

<http://www.diamond-ant.co.jp/english.html>

E-MAIL : orverseas@diamond-ant.co.jp

Note

1. Since the product is used high sensitivity element, be careful about static electricity, thunder (induced thunder) and high electric field.
2. Use the receiving antenna whose impedance is 50Ω for the product. Other antennas are not performed.
3. The product is for 13.8V car. Do not use it for 24V car.
4. The product is a preamplifier for receiving only. Do not transmit. Internal circuit may be damaged and it may be breakdown.

Specification

Frequency	500KHz - 1500MHz
Gain	20dB (Max) ~ -20dB (Min) Turning off the unit will be passing the amplifier.
Impedance	50Ω
NF	3.5dB
IP3	15dBm
Connector	M-J
Power supply	DC13.8V
Electric current consumption	80mA (MAX)
Dimensions (mm)	86(W) x 25(H) x 64(D) mm
Weight	210g
Attachments	Power cable Cigarette lighter plug Magic tape 4pcs of Rubber cushions

Description of the parts

- ① Power/Gain control knob
Turning the Power/Gain control knob clockwise, the product is on and the gain is increased.(Power on-LED on).
Turning the Power/Gain control knob counter clockwise, the gain is decrease.
Turning the Power/Gain control knob extreme counter clockwise will turn the product off.
- ② M-J connector for antenna
Connect with the receiving antenna whose impedance is 50Ω.
- ③ M-J connector for receiver
Connect with the receiver.
- ④ Power supply cable
Connect with power cable or cigarette lighter plug. Power is supplied.

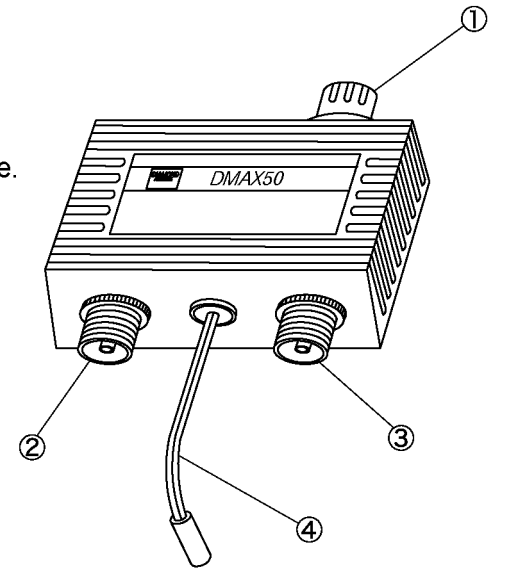

Before using

The unit is consisted of the following parts.

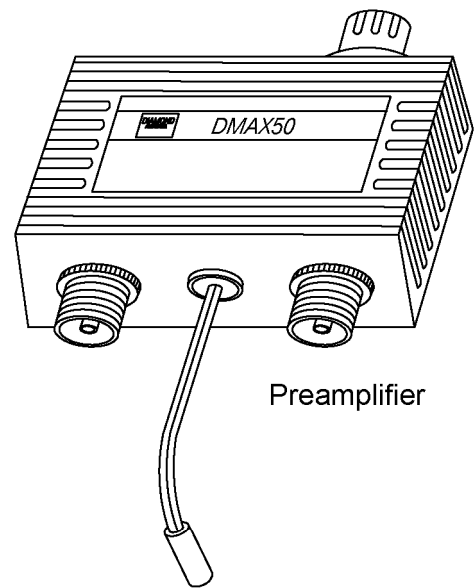

Preamplifier

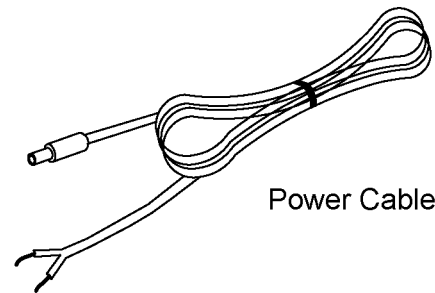

Power Cable

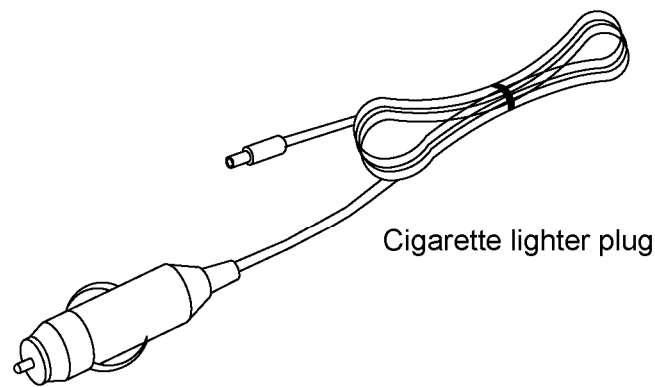

Cigarette lighter plug

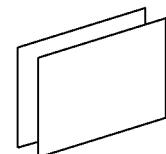

Magic tape



rubber cushion

Operation Instructions

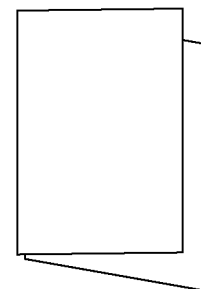

How to use (Fixed Station Antenna)

1. Connect it as shown in below.
※Attach the rubber cushions on the bottom of the preamplifier if you like.
2. Plugging the power cable and turning the power/gain control knob, the product is on. The preamplifier is in use.(LED ON)
3. After receiving the signal you want to listen, adjust the gain control knob ① depending on incoming signal strength to have good sound quality.
4. To use the product by passing through the amplifier, turn the gain control knob extreme counter clockwise to turn the product off.
※At the moment when the product is turned off, the gain of the product returns to 0dB from minus level. And AF gain may be boosted.

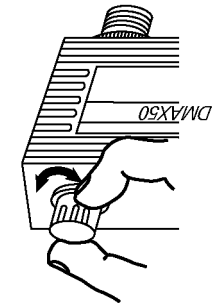

☆When receiving strong signal, turn the control knob counter clockwise to have good sound quality.
When receiving weak signal, turn the control knob clockwise to have good sound quality.

