

receivable

FT-840

OPERATING MANUAL

English
Español
Français

YAESU
FT-840

YAESU MUSEN CO., LTD.



It was hard but I finally got this manual. Now you
also can have it.
Marwan Al-Atrach, 5N0WHA, 5V7MAR

FT-840

English



Contents

<i>Front Panel</i>	
<i>Meter Functions & Display</i>	
<i>General Description</i>	1
<i>Specifications</i>	2
<i>Accessories and Options</i>	3
FC-10 & FC-800 Automatic Antenna Tuners . . .	3
TCXO-4 Master Reference Oscillator	3
SP-6 Speaker	4
YH-77ST Lightweight Headphones	4
FM Unit -747	4
FIF-232C CAT System Interface	4
IF Crystal Filter Options	4
Microphones	5
<i>Station Installation</i>	7
Preliminary Inspection	7
AC Power Supply	7
Changing the FP-800 AC voltage range	7
Transceiver location	8
Grounding	8
Adjusting the front panel angle	8
Antenna considerations	8
Mobile Power Connection	8
Mobile Mounting	9
Mobile Antenna Installation	9
Interconnection of Accessories	9
Memory Backup	9
Connector Pinouts	10
Connecting External Accessories	11
Connecting a Linear Amplifier	12
Power-up Settings	13
<i>Operation</i>	15
Getting Started Tutorial	15
Displaying the 10's of Hz Digit	15
Tuning & Scanning Steps	16
General Coverage Reception	16
Dealing with Interference	17
AGC-F Selection	17
Attenuation	17
Noise Blanker Setting	17
IF Shift adjustment	17
YF-112 A/C IF Filters	17
Locking the DIAL or Buttons	17
Transmitting	18
Button Beeper Settings	18
Automatic Antenna Matching	18
SSB Transmission	19
AF Speech Compression	19
CW Transmission	20
CW Key Connections	20
Reverse CW Sideband	20
Sidetone Volume and Pitch	20
AM Transmission	21
FM Transmission	21
Carrier Offset Display	21
VFO-B & Split Frequency Operation	22
Clarifier (Receiver Offset Tuning)	22
Tuning knob torque adjustment	23
Memory Features	23
Memory Storage	24
Checking Memory Contents	24
Frequency Display Modes	25
Clarifying memories and M-TUNE	25
Memory Recall & Operation	25
Scanning Features	26
Memory Scanning	26
Group Scanning	27
Memory Scan SKIP	27
Memory Blanking	28
Subband Scanning , memories P1~P0	28
Digital Modes	29
TNC Interconnection	29
Transmitter Adjustments	30
Transmitter AF input relationships	30
Frequency Display & Tuning	30
1200 Baud FM Packet	31
Installing Internal Accessories	33
Cover removal	33
IF Filters & FM Unit-747	33
TCXO-4 Enhanced-Stability Oscillator	33
Rear Panel	33
CAT System Computer Control	35
Data returned from FT-840	35
Status Update Data Organization	35
CAT Commands	36
Coding examples	38

Front Panel Controls & Connectors

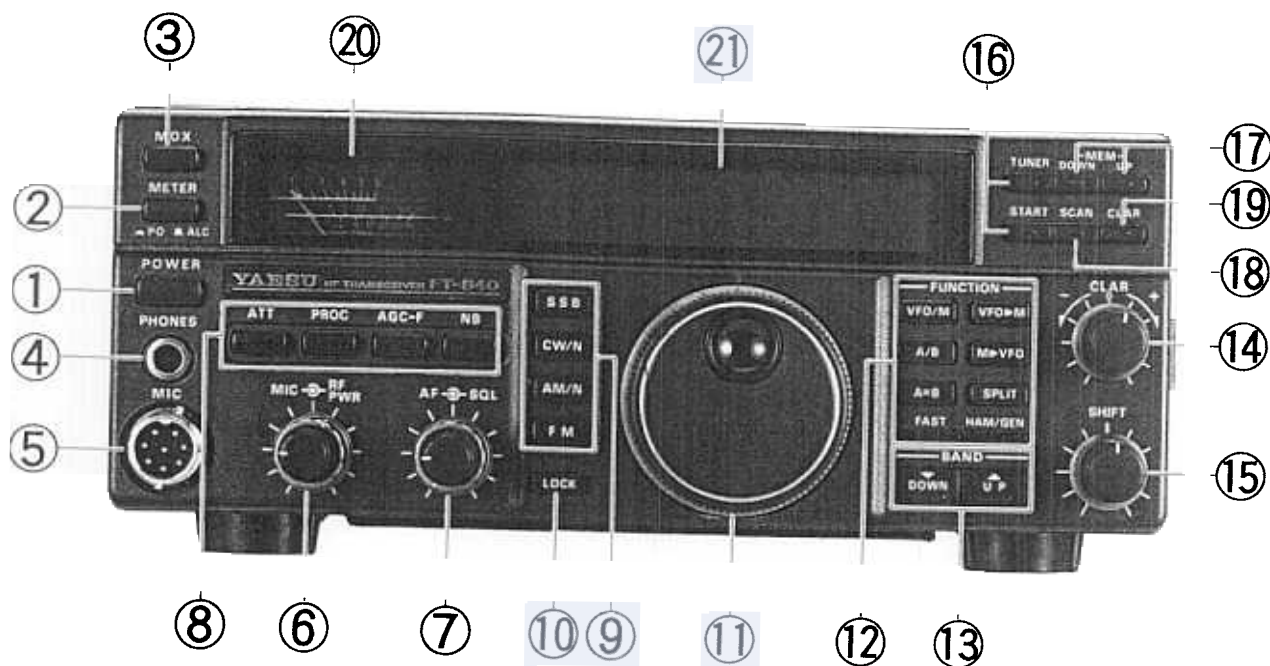

1. POWER This button turns the transceiver on and off. To avoid switching spikes, make sure it is off when you turn the DC power source (AC power supply) on and off. In mobile installations, the transceiver should be off when starting or stopping the engine.

2. METER This button determines the function of the multimeter during transmission. Press to change the selection. The meanings of the abbreviations are as follows: **PO** for Power Output or **ALC** relative Automatic Level Control

3. MOX This button can be used to manually activate the transmitter. It must be in the undepressed (■) position for reception.

4. PHONES This ¼-inch, 3-contact jack accepts either monaural or stereo headphones with a 2- or 3-contact plug. When a plug is inserted, the loudspeaker is disabled. Audio is supplied to both channels of a stereo headphone.

5. MIC This 8-pin jack accepts the MD-1B8 or MD-1C8 Desktop Microphone or the MH-1B8 Handie Scanning Microphone. Proper microphone input impedance is 500 to 600 ohms.

6. The inner **MIC** control adjusts the microphone input level for SSB and AM transmission.

The outer **RF PWR** control sets transmitter output power in all modes. The adjustment range is from less than 15 to 100 W (15 to 25 W AM).

7. The inner **AF** gain control adjusts the volume of the receiver in the speaker or headphones.

The outer **SQL** control sets the signal threshold at which receiver audio is muted (and the **BUSY** indicator turns off), in all modes. This control is normally kept fully CCW, except when scanning, and during FM operation. Scanning stops when the squelch is open. See page 26.

8. ATT If the the band is noisy or very strong signals are present, press this button to insert a 12-dB attenuator in the front end to protect the receiver from overload. **PROC** activates the speech processor in the SSB and AM modes. See page 18. **AGC-F** sets the receiver Automatic Gain Control decay time for fast recovery, which can improve CW reception and fast-fading (QSB) SSB signals. **NB** is used to reduce man-made noise.

9. These four momentary buttons select the operating mode, indicated above the frequency display.

10. LOCK This button toggles locking of the tuning knob to prevent accidental frequency changes. "**LOCK**" appears at the bottom of the display window when locked (the knob can still be turned, but it does nothing). Press again to re-enable the tuning knob. You can change the function of this button to lock most of the controls and buttons, instead of just the tuning knob, by holding the button while switching the transceiver on.

11. This knob tunes the operating frequency of the VFO or a recalled memory. Tuning increments are normally 10 Hz (100 Hz in AM and FM modes). The markings on the knob represent 25 increments each, and one full turn of the knob provides 500 increments (5 kHz, or 50 kHz in AM/FM).

12. — FUNCTION —

VFO/M This button toggles operation between a memory and a VFO. Either **VFO-A** (or **VFO-B**), or **MEM** is displayed to the left of the frequency to indicate the current selection. If a displayed memory has been retuned, pressing this button once returns the display to the original memory contents, and pressing it again returns to the (last used) VFO.

VFO ► M When receiving on a VFO or a retuned memory, holding this button for ½-second writes the current operating data to the currently selected memory. Two beeps sound, and any previous data in the memory is overwritten. Also, pressing and holding this button after recalling a memory (without retuning) causes the memory to be “blanked.” Repeat to unblank the memory.

A/B When receiving on a VFO, this button toggles operation and display between VFOs A and B. On a memory, it toggles front and rear halves.

M ► VFO Pressing this button momentarily displays the contents of the currently selected memory channel for three seconds. Holding this button for ½ second copies all data from the memory to the VFOs, as two beeps sound. Previous data in the VFOs is overwritten. See page 25.

A = B This button copies the contents of the display to the other VFO or memory half. Previous contents of the non-displayed VFO/memory half are overwritten (lost!).

SPLIT This button activates split frequency transceive operation. The displayed frequency is used for reception, and the other VFO or rear half of the memory for transmission. The “**SPLIT**” indicator at the left side of the display is lit while this function is active.

FAST For fast tuning, press this button while rotating the tuning knob or pressing the **UP** or **DOWN** button, to increase the tuning rate ten times. See the table on page 13 for all available steps. When fast tuning is active, “**FAST**” is displayed above the MHz digits. You can set the function of this button to be either “press-and-hold”, or toggle on/off, by holding it while switching the transceiver on.

HAM/GEN This button determines the function of the **DOWN/UP** buttons when receiving on a VFO or retuned memory: **GEN** steps are 100 kHz, and **HAM** steps are from one amateur band to the next.

13. — BAND —

Pressing either of these buttons [**DOWN▼/UP▲**] momentarily steps the operating frequency down or up one ham band, or 100 kHz (if receiving in **GEN** mode), respectively. Pressing **FAST** with one of these buttons steps down or up 1 MHz if receiving in **GEN** mode. Continue holding either button for repeated stepping.

14. CLAR This knob tunes the clarifier offset frequency up to ± 1.25 kHz (or optional ± 2.50 kHz), when activated by the **CLAR** button to the left of it. Operating details are on page 22.

15. SHIFT In modes other than AM and FM, this control offsets the IF passband center frequency from the displayed frequency when turned away from the detented 12-o’clock position.

16. TUNER Pressing this button puts the antenna tuner in line. Reception is not affected. Pressing the **START** button while receiving in a ham band activates the transmitter for while the tuner rematches the antenna for minimum SWR. The resulting settings are stored in the antenna tuner’s 31 memories, for automatic recall later. See page 18.

17. ◀MEM▶ [DOWN/UP] Press these buttons to momentarily step through all memory channels. While doing so from the VFO mode, the “**MEM**” LCD indicator will blink, and if no further buttons are pressed within 3 seconds, activity returns to the last used VFO.

18. SCAN In the VFO mode with the squelch closed, pressing this button starts scanning the entire frequency range of the radio, and pauses when activity is found (according to the scan delay mode selected). In memory channel operation, pressing this button scan the front halves of all stored memories (see page 26).

19. CLAR Pressing this activates the receiver offset (“**CLAR**” displayed) and recalls any previously tuned offset. The clarifier offset display can be hidden by holding this button while turning the transceiver on to toggle the function.

20. The meter indicates the selected parameter during transmission, and signal strength in S-units during reception (on the top scale). Each S-unit is approximately 6 dB. See the following page.

21. The display indicates operating frequency, clarifier offset, memory number and special states. Details are on the following page.

Rear Panel

This red phono jack provides 13.5-V DC (pin positive) at up to 200 mA for powering an external accessory.

CAUTION! The line is not fused, so be careful not to reverse polarity or draw more than 200 mA, as serious damage can result!

Use this control to adjust speech processor compression as described on page 19.

The **DELAY** control serves to set CW semi-break-in timing, as described on page 20.

Connect your CW key, keyer paddles or external keyer to this 1/4-inch 2-contact jack. Wiring is on page 20. Open circuit voltage is +5 V DC, and closed circuit current is 0.7 mA.

This phone jack provides constant-level receiver audio output for use with a packet TNC or other terminal unit. Output level is approximately 100 mV peak at 600Ω. See page 30.

This phono jack accepts external ALC (Automatic Level Control) voltage from a linear amplifier, to prevent over-excitation. ALC voltage range is 0 ~ -4 VDC.

This yellow phono control input jack can be used to activate the transmitter remotely (by shorting the contacts). Open circuit voltage is 13.5 V, and closed circuit current is 15 mA.

This grill is the air outlet for the cooling system. Make sure nothing blocks this grill in your installation, as air must be free to exit here for proper cooling.

Connect the 50-Ω coaxial feedline to your antenna or external ATU here using a type M (UHF, PL-259) plug. Do not operate the transceiver without an antenna or dummy load!

Connect this terminal to a good earth ground, for safety and optimum performance.

This is the 13.5-volt DC power connector. Connect a 20-A supply as shown below. See also the Caution on page 7.

This 8-pin jack outputs control signals for the FL-7000 Linear or FC-1000 ATU, including band selection data to set the Linear or Tuner to the same band as the FT-840. Pinout is on page 10, and QSK connections on page 11.

This 8-pin mini DIN jack is for the FC-10 External Automatic Antenna Tuner. Pinout diagram is on page 10.

This 5-pin mini DIN jack is for the FC-800 External Automatic Antenna Tuner. Pinout diagram is on page 10.

This 6-pin mini DIN input/output jack allows external computer control of the FT-840. Signals levels are TTL (0 and 5 V DC). Pinout is on page 10, and the signalling protocol and data formats are described in the CAT chapter, starting on page 35.

Use this control to adjust CW side tone level heard during CW operation, as described on page 20.

This 2-contact mini phone jack provides receiver audio for an external loudspeaker, such as the one provided in the FP-800, or the SP-6. Inserting a plug in this jack disables the internal loudspeaker. Impedance is 4 to 8 Ω.

Note: The only required connections for operating the transceiver are DC power (below) and an antenna. Also, a proper ground is highly recommended, and may be necessary for proper operation. All other rear panel connections are optional.

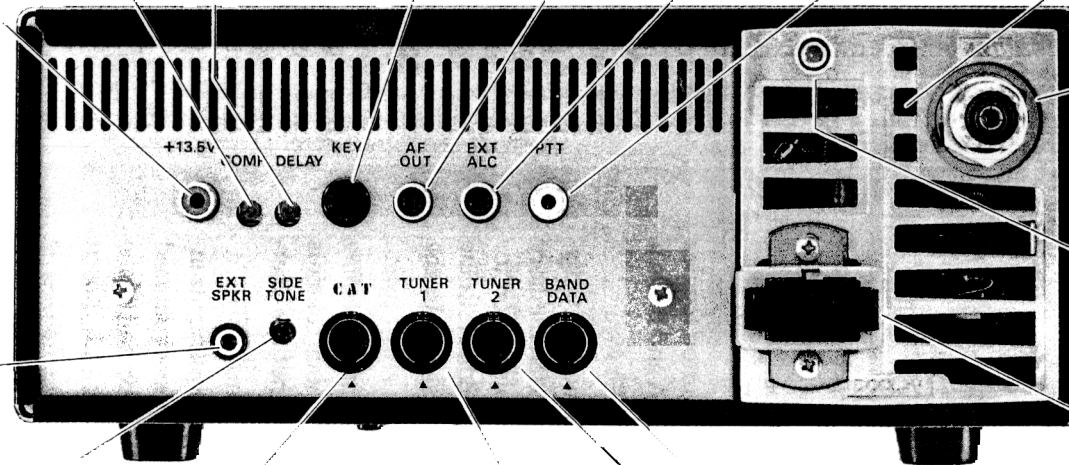

Front Panel LCD

This indicator appears when external computer-aided-transceiver control is being used (with optional FIF-232 interface box).

This indicator appears whenever the transmitter is activated (PTT).

This indicator appears whenever the squelch is open (while receiving).

This indicator appears whenever split-frequency operation is activated (by pressing the SPLIT button).

This indicator appears whenever general coverage tuning is selected (via the HAM/GEN button).

This MEM indicator shows memory operation is selected (by pressing the VFO/M button). It blinks after pressing the M ► VFO or VFO ► M button, to indicate that Memory Checking is active. While it is blinking, you can press the MEM-DOWN/UP buttons to check the contents of memories, without affecting operation. Wait 3 seconds and Memory Checking stops. See page 23.

One of these five indicators shows the current operating mode as selected by the buttons to the left of the tuning knob,

One of these two indicators shows the current VFO selected by the A/B button to the right of the main tuning knob.

(NARrow IF filter) While operating in the AM or CW mode, pressing the AM/N or CW/N button, respectively, toggles this indicator and the narrow IF filter for that mode (both filters are optional). Press the same button again to return to the wide IF filter.

This indicator appears when the automatic antenna tuner detects an abnormally high SWR that it cannot match.

This indicates that an automatic antenna tuner is connected to the appropriate rear panel connector and selected for operation (on-line).

This indicator appears while the automatic antenna tuner is seeking an impedance match with the antenna. It also flashes each time the main microprocessor sends frequency update data to the tuner microprocessor (while you tune).

These two small digits display the ch. number when operating on a memory. For VFO operation, you can turn these off by holding the VFO ► M button while switching the transceiver on to toggle this choice.

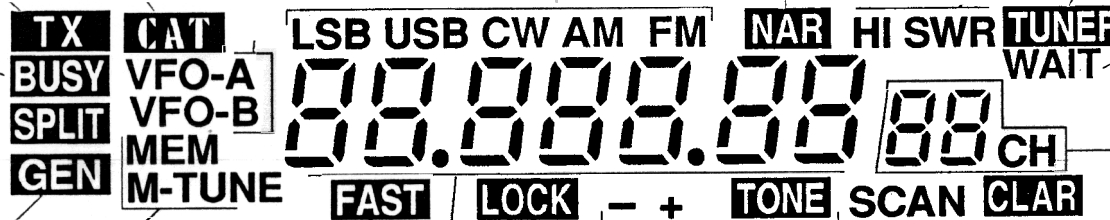

This indicator appears whenever the fast (x 10) tuning rate is activated by the FAST button to the right of the tuning knob.

This is the current operating frequency, with decimals at the MHz and kHz positions. The rightmost large digit is 10's of Hz. The displayed frequency changes when you transmit with either clarifier offset or split transceiver enabled. While selecting memories during Memory Checking, the decimal points appear when the selected memory is vacant while the frequency display is blank.

One of these segments lights along with the TONE indicator when the FM repeater function is activated, indicating the repeater offset. TONE indicates the CTCSS tone is also activated to access CTCSS-controlled repeaters (page 21).

This indicator appears whenever the main tuning knob is locked (still turns but freq. does not change) by pressing the LOCK button below the mode selection keys. Front-panel keys can also be locked by holding this button while turning the set on to toggle this function (page 17).

This indicator appears when the Clarifier (receiver offset) is activated by the CLAR button. Remember that your transmit frequency may be different from the display when this indicator is visible!

(Memory scan select) This indicator appears when displaying a memory that has been selected to be scanned. It is not displayed if the memory has been tagged to be skipped during memory scanning (pg. 26).

Meter Functions

Note: While receiving, refer only to the S-meter function: the top scale of the meter.

*While transmitting, the meter function is determined by the **METER** button to the left of it.*

During reception, the top "S" scale indicates incoming signal strength in S-units at the left end of the scale, and in dB above S-9 at the right end. Each S-unit is approximately 6 dB.

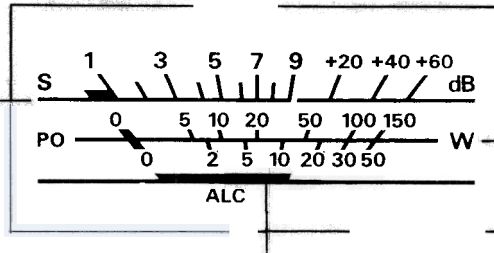

The second, "PO" scale indicates transmitter power output, in watts, when selected by the **METER** button in the depressed (**PO**) position. This scale is calibrated to be most accurate when the antenna impedance is 50-Ω. Refer only to the numbers above the scale (0 - 150) for the FT-840; the numbers below apply only to special low-power versions.

The bottom "ALC" scale indicates transmitter Automatic Level Control voltage when selected by the **METER** button in the undepressed (**ALC**) position. The position and movement of the meter needle give a good indication of transmitter performance. This meter function is important when setting the **MIC** gain control for SSB and AM modes, and the **RF PWR** control in CW and FM modes. See the Transmitting instructions beginning on page 18.

General Description

The FT-840 is a high-performance transceiver providing up to 100 watts transmitter output power on all HF amateur radio bands in CW, SSB and FM modes, and up to 25 watts carrier in AM. The receiver tunes all frequencies between 100 kHz and 30 MHz in 10-Hz steps. Ease of operation and flexible features are combined in a compact, reliable rig that both beginners and seasoned operators will enjoy.

Modular circuit design employs surface-mount components on composite epoxy boards for high reliability and serviceability. Twin direct-digital synthesizers (DDSs) and a magnetic rotary encoder provide silent, silky-smooth tuning. Frequency accuracy and stability are assured by driving both DDSs from a single master oscillator, and the optional TCXO-4 temperature-compensated crystal oscillator is available for enhanced ± 2 ppm stability from 0 ~ +50° C.

The FT-840 features a low-noise, high performance receiver front end. Interference rejection is facilitated by the unique "up-down" conversion scheme, and includes an IF shift circuit. The optional YF-112C crystal filter can be installed to provide enhanced CW reception, and an AM-wide filter is also available for greater fidelity during broadcast reception.

A few new features have been introduced that CW enthusiasts will enjoy. The CW reverse sideband feature lets you switch the receiver carrier point (offset) to help sidestep QRM and not have to re-tune signals when changing between LSB and CW modes (really convenient when working 40 meters and below). If you use a multi-mode TNC or CW decoder, the adjustable BFO offset lets you match the CW pitch to that used by your unit for best CW copy.

A 16-bit microprocessor in the FT-840 is programmed to provide the simplest possible control interface for the operator. Two independent (A/B) VFOs for each band (20 total) hold their own frequencies and modes settings. One-hundred memories store all of this data for both VFOs, giving a total of 220 independent sets of frequency, mode and other selections. Flexible scanning features allow all 100 memories or only those selected to be freely-tuned and scanned. Group scanning allows you to organize your memories into ten groups, and only scan channels within a selected group. In addition, ten special memories also let you limit the tuning/scanning range between their stored frequencies. Scan resume is selectable be-

tween timed or carrier-delay, and scanning speed is also adjustable.

Other valuable features include an effective noise blanker, all-mode squelch, multi-function meter, and an AF speech compressor which lets you increase the average power of your SSB and AM signal.

The FT-840 weighs under 5 kg and an internal thermally-switched fan allows full transmitter output without any rear panel protrusions, giving easy access to rear panel controls and connectors.

A choice of two external automatic antenna tuners makes multi-band operation with a single antenna as simple as pressing a button. The FC-10 is a compact, automatic antenna-tuner styled to match the size and appearance of the FT-840, and fits neatly into your shack. A simple two-cable connection to your FT-840 is all that is required for operation. For more demanding applications, the FC-800 tuner unit can be mounted outside at the antenna feedpoint (or in the trunk of your car for mobile use) for optimum performance. Both automatic tuners are controlled from the front panel of the transceiver.

Other accessories include the FP-800 AC Power Supply with Loudspeaker; the SP-6 External Loudspeaker with audio filters; the MMB-20 Mobile mounting bracket; the YH-77ST Headset; and the MD-1C3 Desktop and MH-1B8 Hand Microphones.

Before connecting the power cord, you should read the Installation section carefully, heeding the warnings in that section to avoid damage to the set. After installation, please take time to work through the Operation chapter, referring to the fold-out panel diagrams at the back of the manual as necessary for details. This manual is intended to be read while sitting down in front of the FT-840, so you can try out each control and feature as they are described.

Specifications

General

Receiving Frequency range: 100 kHz ~ 30 MHz

Transmitting Frequency Ranges:

160 ~ 10 meter Amateur Bands

Frequency stability: ± 10 ppm (or ± 500 Hz FM),
from 0 ~ +40° C and ± 2 ppm (or ± 300 Hz FM),
from 0 ~ +50° C (w/TCXO-4 option)

Emission modes: USB, LSB(J3E), CW(A1A),
AM(A3E), FM (F3E)

Frequency Tuning Steps: 10 Hz/100 Hz (CW, SSB)
100 Hz /1 kHz (AM, FM)

Antenna impedance: 50 Ω nominal

Operating temp. range: -10 ~ +50° C

Supply voltage: 13.5-V DC $\pm 10\%$ negative ground

Power consumption (approx): 1.2 A rx (no signal)
20 A tx (100 watts)

Dimensions (WHD) 238 x 93 x 243mm

Weight (approx): 4.5 kg

Transmitter

Power Output: adjustable up to 100 watts
(25 watts AM carrier)

Modulation types: SSB: Balanced, filtered carrier
AM: Low-level (early stage)
FM: Variable reactance

Maximum FM Deviation: ± 2.5 kHz

Harmonic radiation: > 50 dB below peak output
45 dB (10, 18 MHz)

Spurious Radiation: > 40 dB below peak output

SSB carrier suppression: > 40 dB below peak output

Undesired sideband suppression: at least 50 dB
below peak output at 1.5 kHz modulation

Audio response (SSB): not more than -6dB
from 400 ~ 2600 Hz

3rd-order IMD: -25 dB @ 100 watts PEP, 14.2 MHz

Microphone impedance 500 to 600 Ω

FM operation requires installation
of the optional FM UNIT-747.

Receiver

Circuit type: dual-conversion superheterodyne

Intermediate frequencies: 1st: 47.055 MHz
2nd: 8.215 MHz
3rd: 455 kHz (FM)

Sensitivity:

(for 10 dB S/N, 0 dB μ = 1 μ V FM 12 dB SINAD)

Frequency Mode (BW) \Rightarrow \Downarrow	150 ~ 250 kHz	250 ~ 500 kHz	0.5 ~ 1.8 MHz	1.8 ~ 30 MHz
SSB, CW (2.4 kHz)	< 5 μ V	< 2 μ V	< 1 μ V	< 0.25 μ V
AM (6 kHz)	< 40 μ V	< 16 μ V	< 8 μ V	< 1 μ V
FM (28 ~ 30 MHz) (8 kHz)	—	—	—	< 0.5 μ V

Selectivity: (-6/-60 dB): ripple 3dB or better

Modes	Minimum 6 dB BW	Maximum 60 dB BW
CW narrow (optional)	500 Hz	1.8 kHz
SSB, CW, AM narrow	2.2 kHz	5.0 kHz
AM-wide (optional)	6 kHz	14 kHz (-50 dB)
FM (optional)	8 kHz	19 kHz

Squelch sensitivity:

1.8 ~ 30 MHz (CW, SSB, AM): < 2.0 μ V
28 ~ 30 MHz (FM): < 0.32 μ V

IF rejection (1.8 ~ 30 MHz): 60 dB or better

Image Rejection (1.8 ~ 30 MHz): 70 dB or better

IF Shift Range: ± 1.2 kHz

Clarifier tuning range/steps: ± 1.25 kHz/ 20 Hz
 ± 2.50 kHz/ 10 Hz

Maximum audio power output:
at least 1.5 watts into 4 Ω with < 10% THD

Audio output impedance: 4 to 8 Ω

Specifications are subject to change, in the interest of
technical improvement, without notice or obligation.

Accessories & Options

Supplied Accessories

Hand-held Microphone (1 pc)

Fused DC Cable (1 pc)

20-A Fuse (1 pc)

English

Options

FC-10 Compact External Auto-Antenna Tuner

The FC-10 is a compact, easy-to-use automatic antenna tuner unit styled to match the FT-840 in size and appearance. It's small size enables it to sit next to the FT-840 while not taking up valuable space in your shack. The FC-10 requires only two simple cable connections to the rear panel of the transceiver, and is controlled entirely from the front panel of the FT-840.

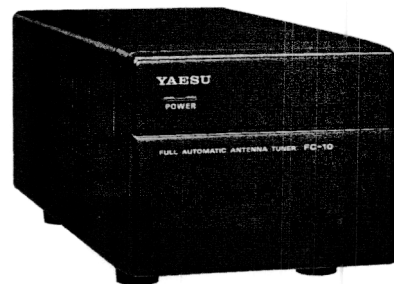

FC-800 Automatic Antenna Tuner

The FC-800 (external remote) antenna tuner match impedances of up to about 3:1 with the transmitter. Operation is controlled from the front panel. The FC-800 plugs into the rear panel, and can be mounted at the antenna feedpoint to avoid feedline losses.



TCXO-4 Master Reference Oscillator

For special applications and environments where extra frequency stability is essential, the TCXO-4 temperature-compensated crystal oscillator is a 2-ppm (from 0 to +50 °C) replacement for the reference oscillator.





SP-6 Loudspeaker with Audio Filters

Selectable audio high- and lowpass filters with a large loudspeaker complement the audio characteristics of the FT-840 with your choice of 12 different audio filtering combinations. Two input terminals are provided for multiple transceivers, with a front panel switch to select between them. A phone jack is provided on the front panel to take advantage of the audio filters with headphones.

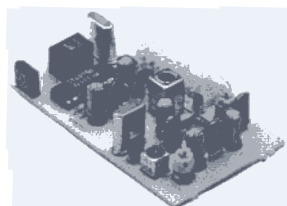

FM Unit -747

Installing this unit permits narrow-band FM reception and transmission, as used with 29.0 MHz Amateur 10-meter simplex and repeater operation.



YH-77ST Lightweight Headphones

Dual Samarium-Cobalt transducers with sensitivity of 103 dB/mW (2 dB @ 1 kHz, 35 Ω) provide the perfect match for the FT-840, taking full advantage of the spectacular audio performance.



FIF-232 CAT System Interface

To control your FT-840 from an RS-232C serial port of an external personal computer, use the FIF 232C to convert the TTL levels required by the transceiver to the RS-232C levels required by the serial port. A cable is included for connections between the transceiver and the FIF-232 (the cable to the computer must be provided separately). The FIF-232 includes its own power supply.

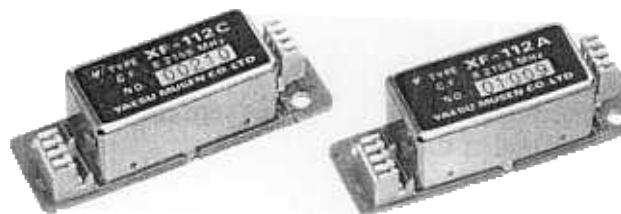

IF Crystal Filter Options

For extra CW receiver selectivity, the 500-F YF-112C 8-pole crystal filter may be installed in the 8.215-MHz 2nd IF of the FT-840. The 6-kHz Y 112A is also available for improved AM reception.

Accessories & Options

Microphones

Matching the electrical and cosmetic features of the FT-840, the MH-1B8 Hand Mic and MD-1C8 Desktop Mic have 600-Ω impedance, and include **UP/DWN** scanning buttons and a large PTT switch. The MH-1B8 also has a 2-position transmit audio characteristic selector, while the MD-1C8 has a 3-position selector. Typical audio characteristic plots with the different switch settings are indicated in the graphs below.

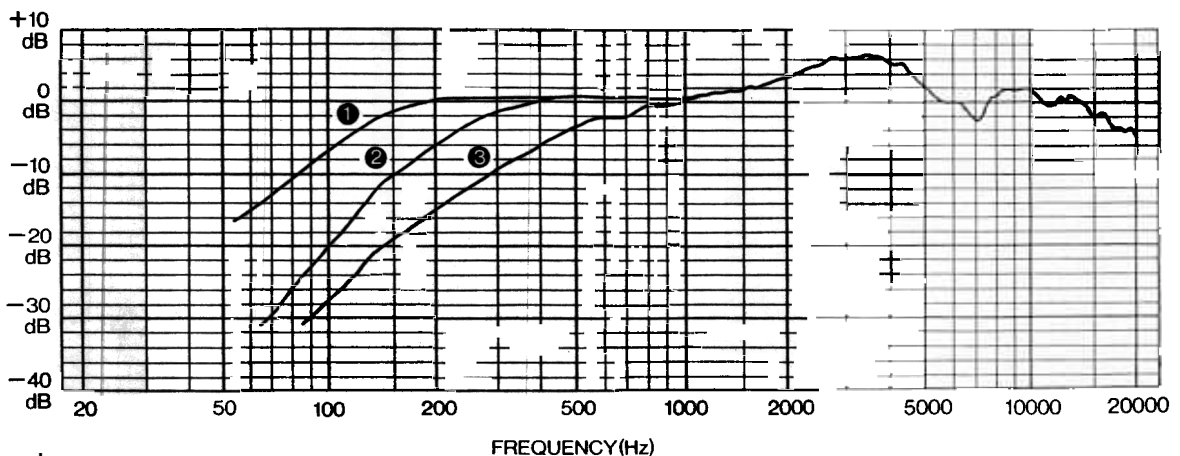
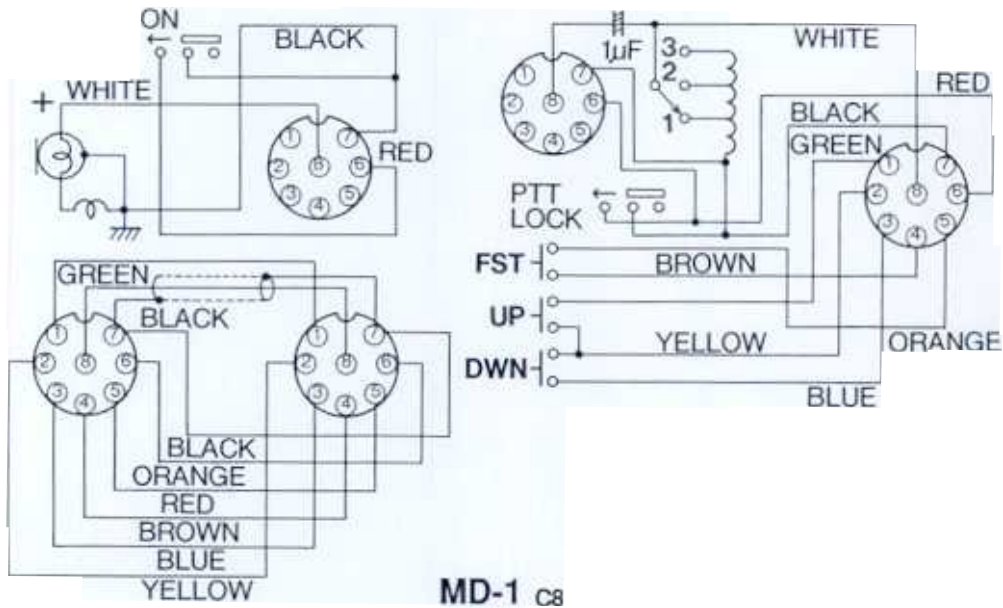
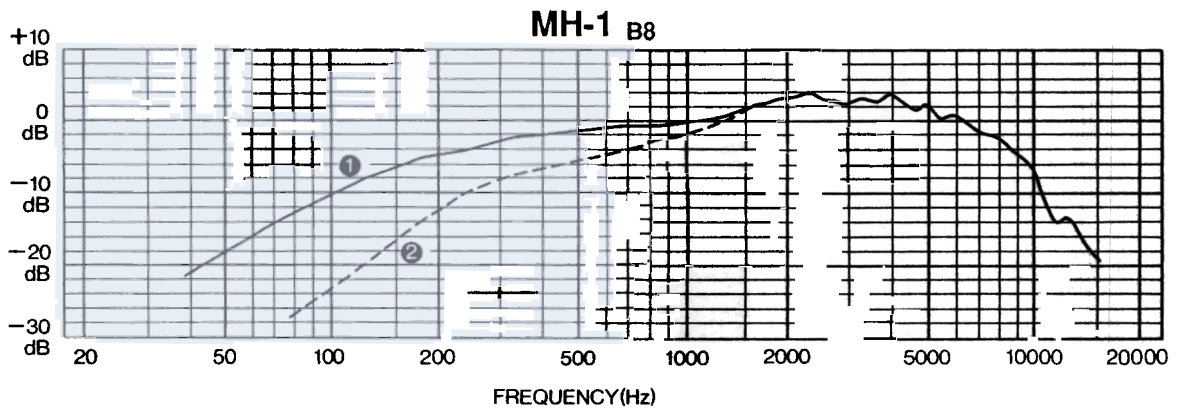
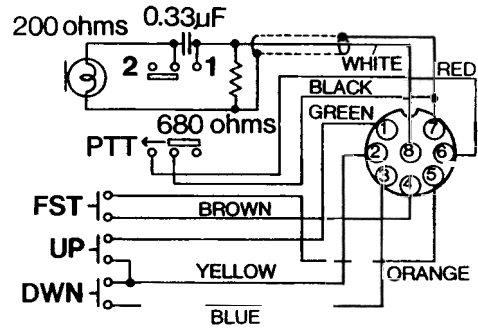

Station Installation

Preliminary Inspection

Inspect the transceiver thoroughly immediately upon opening the packing carton. Confirm that all controls and switches work freely, and inspect the cabinet for any damage. Make sure the accessory uses and cable pictured on page 3 are included. If any damage is found document it completely, and contact the shipping company (or dealer, if you purchased it over the counter) right away. Save the packing materials in case you need to return the set for service.

If you purchased optional internal accessories separately, install them as described in *Installing Internal Accessories* (page 33). This chapter describes base station installation first, followed by mobile installation and then interconnections with external accessories.

AC Power Supply

The FT-840 is designed for operation from 13.5-V DC, negative ground. For base station installations, we recommend the matching Yaesu FP-800 AC power supply which was specifically designed for this purpose, and which includes a large loudspeaker for the transceiver and its own cooling fan. You can use another DC source capable of providing 20 amperes at 13.5-V DC with the supplied DC

Caution!

Permanent damage can result if improper supply voltage is applied to the transceiver. Your warranty does not cover damage caused by application of AC, reversed polarity DC, or DC outside of the specified range of 13.5 V ±10%.

If using a power supply other than the FP-800, ensure the DC supply connector to the transceiver matches the FT-840 requirements. Other manufacturers have power supplies with a physically matched connector that is wired differently: this will cause serious damage to the FT-840!

cable assembly, but you must be extremely careful to avoid reversed polarity connection. See the *Caution* box above.

If you are connecting the FP-800 with the FT-840, before connecting power, check the label on the rear of the FP-800 which indicates the AC mains voltage range for which the supply is cur-

Changing the AC Voltage Range of the FP-800 Power Supply (Not CE marked)

- Disconnect the AC cable from the rear of the FP-800, and the DC cable from the FT-840.
- Remove the 8 screws affixing the top cover.
- Unsolder the wires from the transformer, and resolder for the required voltage as indicated below.
- Replace the fuse in the rear panel holder with a fast-blow, 8-A fuse (for 100 ~ 117-V AC) or 4-A (for 200 ~ 234-V AC).
- Check your work carefully, then replace the top cover and its 8 screws. Change the voltage marking on the FP-800 rear panel label, and replace the AC cord, if necessary.

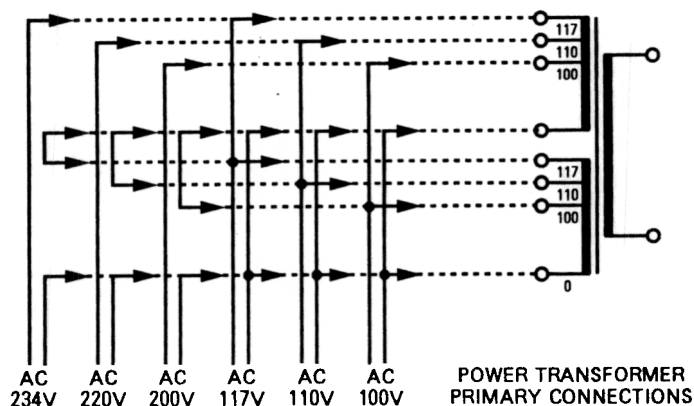

Important!

If you change the AC voltage range you must change the fuse in the rear panel holder. Do not use a slow-blow fuse. Also make sure to change the voltage marking on the label on the rear panel to match the new voltage setting.

English

Station Installation

rently set. If your AC mains voltage is outside of this range, the transformer taps inside the power supply must be rewired, and the fuse in the FP-800 must be changed. This involves some soldering of the AC mains input (see previous page, bottom), so you should ask your dealer for assistance if you are not experienced with this sort of work. *Incorrect connections could cause serious damage not covered by the warranty.*

In any case, make sure the power supply is set correctly before connecting power. If you have any doubts about the procedure, ask your dealer for help.

You should also make sure the fuse in the FP-800 rear panel fuse holder is correct for your mains voltage:

AC Mains Voltage	Fuse Capacity
100 ~ 117	8 A
200 ~ 234	4 A

After making certain the AC voltage for which the power supply is set matches your mains voltage, and that the correct fuse is installed in the fuse holder, connect the DC cable from the power supply to the jack on the rear panel. Don't plug the power supply cord into the wall until all other transceiver interconnections have been made.

Transceiver Location

To assure long life of the components, make sure to provide adequate ventilation around the cabinet. The cooling system of the FT-840 must be free to draw cool air in at the side of the transceiver, and to expel warm air out of the rear panel. Do not place the transceiver on top of another heat-generating device such as a linear amplifier, and do not place equipment, books or papers on top of the transceiver. Place the transceiver on a hard, flat surface. Avoid heating vents and window locations that could expose the transceiver to excessive direct sunlight, especially in hot climates.

Grounding

For protection from shock and proper performance, connect the **GND** terminal on the rear panel to a good earth ground, using a heavy braided cable of the shortest length possible. *Do not use gas lines as a ground connection.* All other station equipment should be connected to the same grounding cable, as close together as practical. If you use a computer with or near the FT-840, you may need to experiment with grounding of both the transceiver and the computer to suppress computer noise in the receiver.

Adjusting the Front Panel Angle

If your installation places the FT-840 much below eye level, you may want to prop up the front. A wire bail on the bottom of the FT-840 can be folded down for this purpose.

Antenna Considerations

Any antenna connected to the FT-840 should have a coaxial feedline with 50- Ω impedance, and include a well-grounded lightning arrestor. The FC-10 and FC-800 antenna tuners are capable of matching antennas with an SWR of up to 3:1 or more on the amateur bands to the transmitter. Nevertheless, optimum performance for both reception and transmission will generally result with an antenna designed to provide a 50- Ω unbalanced resistive load at the operating frequency. An antenna that is not resonant at the operating frequency may present too high an SWR for proper matching with the antenna tuner, in which case the antenna should be readjusted, or a wide-range manual antenna tuner should be used. If the tuner is unable to bring the SWR down to an acceptable level, attempting to transmit will result in an automatic reduction in power output and increased losses in the feedline. Operation under such conditions can waste power and cause TVI, RFI and RF feedback: it is better to install another antenna designed for that band. Also, if your antenna has a balanced feedpoint and you use a balanced feedline, install a balun transformer between the feedline and the transceiver's antenna jack.

Mobile Power Connection

A fused (20-A) DC power cable for mobile installation is supplied with the transceiver. Please note the *Caution* at the beginning of this chapter before connecting power. Plan to connect the DC cable directly to the vehicle battery, rather than to the ignition or accessory circuitry. Route the cable as far away from ignition cables as possible, and then cut off any extra cable (from the battery end) to minimize voltage drop losses. If the cable is not long enough, use #12 AWG stranded, insulated wire to extend it, but no more than is necessary. Use the following procedure to connect the cable:

- Before connecting the cable, measure the voltage across the battery terminals with the engine running fast enough to show a charge. If above 15 volts, the automobile voltage regulator must be adjusted to reduce the charging voltage before proceeding.
- With the radio end of the cable unconnected, connect the RED cable lead to the POSITIVE battery terminal, and the BLACK lead to the

NEGATIVE terminal. Make sure the battery terminal connections are tight, and remember to check them periodically for signs of loosening or corrosion.

- Make sure the **POWER** switch on the transceiver is off, and plug the DC cable into the 6-pin molex jack on the rear panel.

Caution!

*In mobile installations, check to ensure that the transceiver **POWER** switch is off whenever starting or stopping the engine, to avoid damage from switching transients.*

Mobile Mounting

The optional MMB-20 Mobile Mounting Bracket allows quick insertion and removal of the transceiver from the vehicle. Complete instructions are provided with the bracket, which can be mounted above or below the transceiver.

MMB-20 Mobile Mounting Bracket

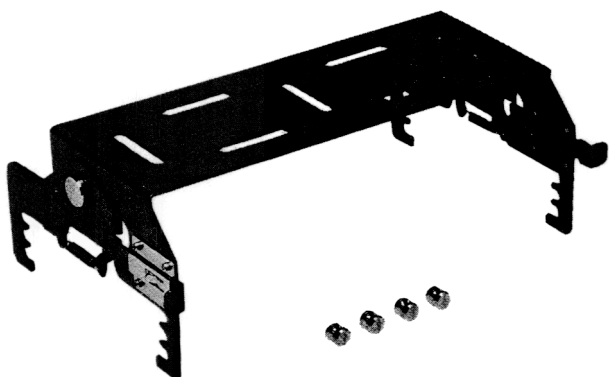

Mobile Antenna Installation

Please review the Antenna Considerations on the previous page, as they apply equally to base and mobile antennas. The FC-800 Remote Antenna Tuner is particularly desirable in a mobile station, where the short antenna elements have very narrow bandwidth. Make sure that the shield of the antenna coax is firmly grounded to the car body at the antenna feedpoint if using a base-loaded vertical.

Interconnection of Accessories

The diagrams on the following pages show interconnections of external accessories. If you have

any questions on these accessories or connecting devices not shown, contact your dealer for advice.

Memory Backup

The lithium memory **BACKUP** switch inside the hole in the center of the bottom panel is turned on at the factory, allowing VFO and memory data to be retained while power is off. Backup current is miniscule, so it is not necessary to turn the **BACKUP** switch off unless the transceiver is to be stored for a long time.

After about five years the transceiver may fail to retain memories (although operation will be otherwise unaffected), and the lithium battery should be replaced. Ask your dealer for replacement of the battery, or for instructions on how to do so yourself, see page 34.

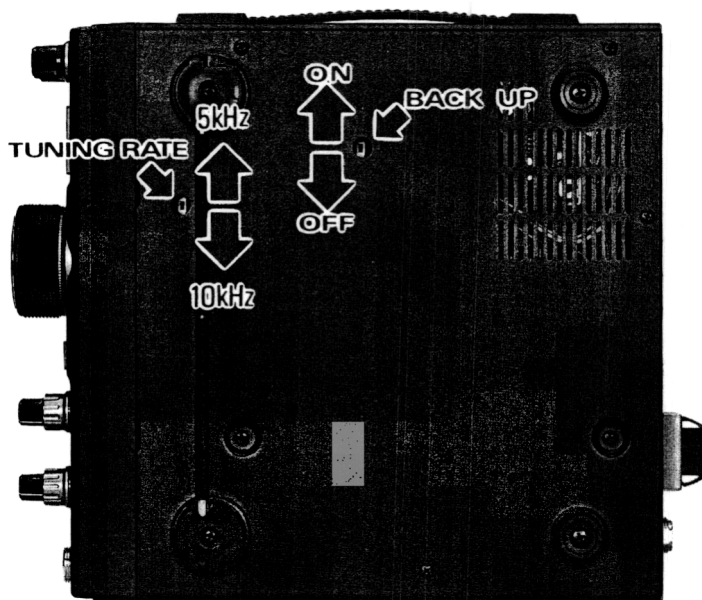

Switch Locations in Bottom Cover

Station Installation

Connector Pinouts

English

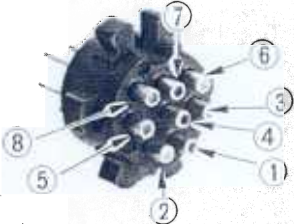
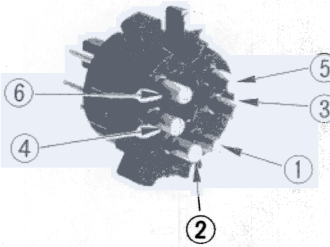
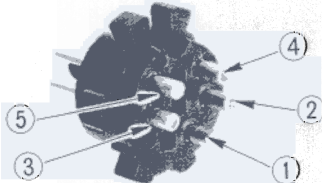
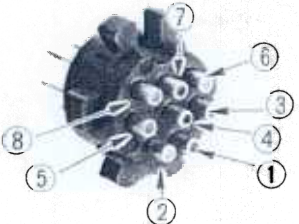
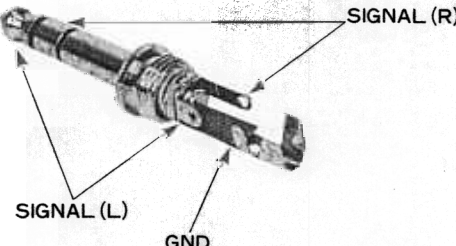
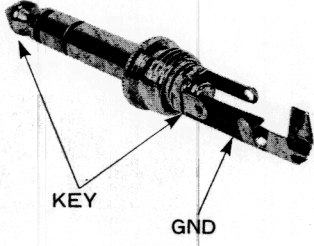
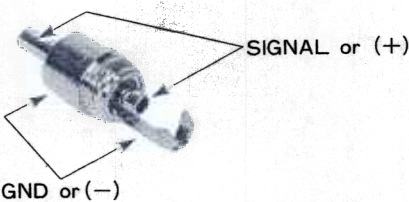
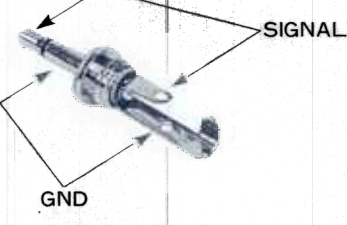
BAND DATA	CAT
 <ol style="list-style-type: none"> 1. +13.5 V 2. TX GND 3. GND 4. BAND DATA A 5. BAND DATA B 6. BAND DATA C 7. BAND DATA D 8. LINEAR 	 <ol style="list-style-type: none"> 1. GND 2. SERIAL OUT 3. SERIAL IN 4. PTT 5. S/PO 6. NC
TUNER 1 (used w / FC-800)	TUNER 2 (used w / FC-10)
 <ol style="list-style-type: none"> 1. GND 2. +13.5V 3. DATA 4. GND 5. GND BY FC-800 	 <ol style="list-style-type: none"> 1. +13.5V 2. TX GND 3. GND 4. DATA IN 5. DATA OUT 6. TUNER SENSE 7. RESET 8. TX INH
PHONES	KEY
 <p>SIGNAL (R)</p> <p>SIGNAL (L)</p> <p>GND</p>	 <p>KEY</p> <p>GND</p>
RCA PLUG	EXT SPKR
 <p>SIGNAL or (+)</p> <p>GND or (-)</p>	 <p>SIGNAL</p> <p>GND</p>

Connecting External Accessories

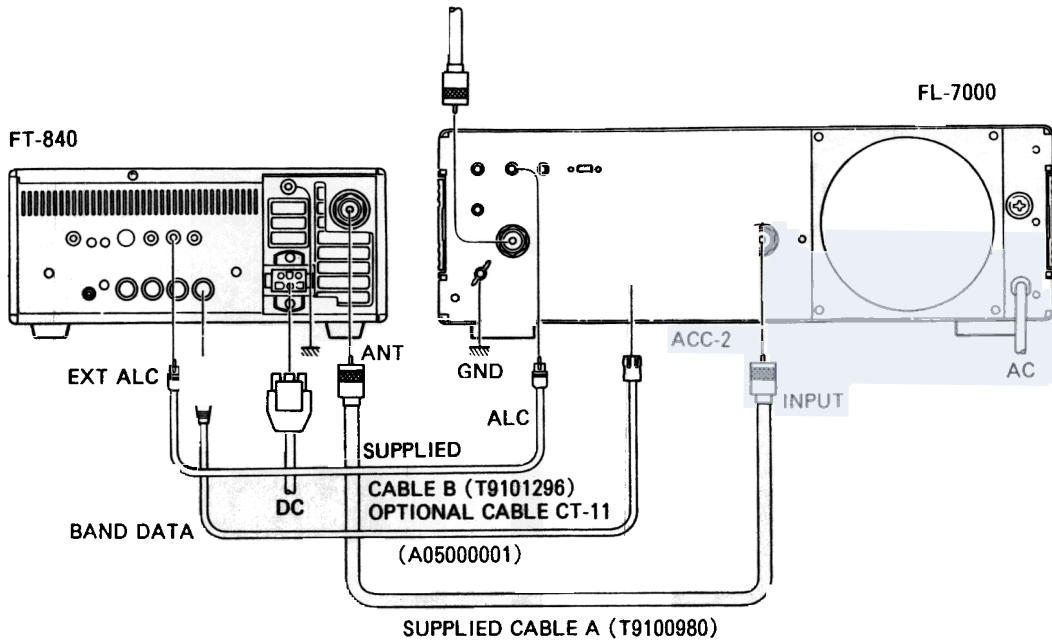

FL-7000 Linear Amplifier

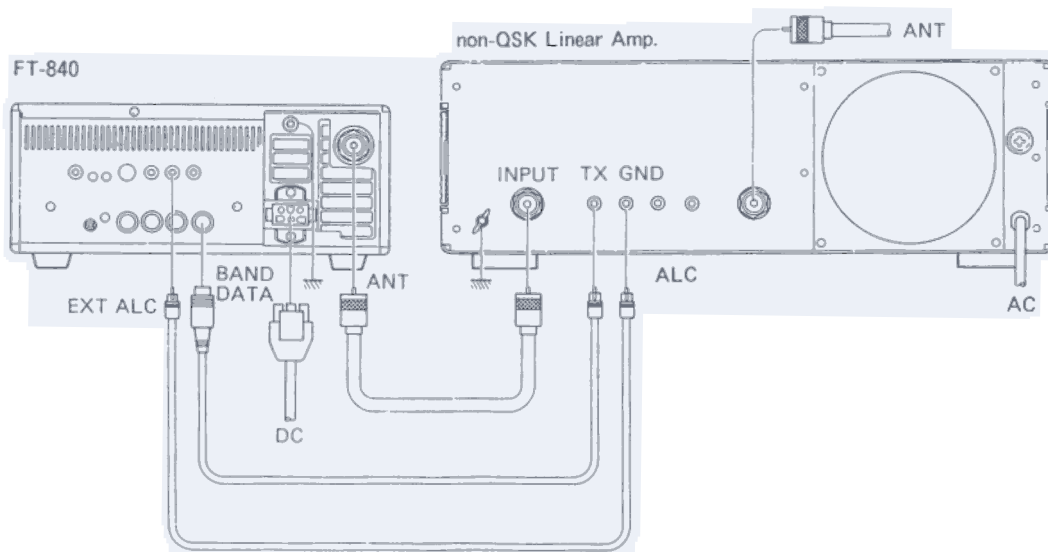

Other non-QSK Linear Amplifier

Connecting a Linear Amplifier

For all linear amplifiers, connect the ALC output from the linear to the **EXT ALC** jack on the rear of the transceiver. After making the RF and t/r switching connections described below, you will probably need to adjust the ALC output level of the linear so that it is not overdriven by the FT-840. Your linear's manual should describe how to do this.

If using an FL-7000 with the FT-840, use optional cable CT-11 to provide automatic band selection for the linear, as well as t/r switching control. If using another linear, and if it can be switched with less than 1500 mA of DC voltage below 150 V, you can connect the the t/r switch line for the linear to pin 2 of the **BAND DATA** jack, and the linear's exciter-enable output to pin 8 of the **BAND DATA** jack. This line must be held high (+5 to 15 V) to inhibit transmission until the linear is ready for excitation by the FT-840. If your linear amplifier requires more than 1500 mA or uses more than 150 V for t/r relay switching, you will have to provide a suitable external interface transistor/mechanical relay (such as the FRB-757 relay box), controlled by pin 2.

Caution!

*The FT-840 is designed for use and easy connection with the FL-7000, when operation with a linear amplifier is required. We recommend using an external t/r relay for operation with all other amplifiers that exceed the voltage and current ratings described above. Using pins 2 and 8 of the **BAND DATA** jack for other amplifiers will not work unless the control line signals are carefully matched, and damage may result otherwise. Your warranty does not cover damage resulting from improper connections to this jack, so if you are unsure, use the **TX GND** jack only.*

(on rear panel)

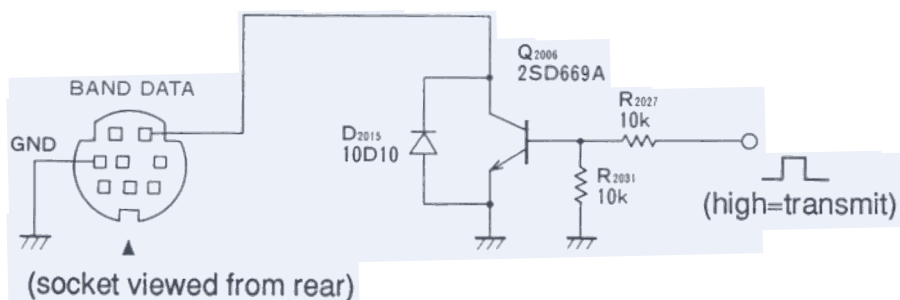

Linear Amp T/R Switching in the FT-840

Power-Up Customization & Button Combination Settings

By pressing and holding certain buttons *while switching on the FT-840*, you can customize features as desired, and perform some troubleshooting functions. Other settings can also be selected by holding the **FAST** button while pressing certain other buttons, as described below. Default settings are in *italics*.

Power-Up Functions	Hold this button	Comments
Panel Button Beeper <i>Enable/Disable</i>	A = B	Press a button to see if the beeper is enabled.
Display <i>BFO Offset</i> or Carrier Freq. in CW mode	BAND-DOWN	BFO Offset added to displayed CW frequency. Affects display only.
<i>Enable/disable</i> 10-Hz Digit at right end of display,	BAND-UP	Affects display only.
Make FAST Button <i>press-on/press-off</i> , or active-only-while-pressed	FAST	"FAST" is displayed when active.
<i>Display/hide</i> clarifier receiver offset.	CLAR	Affects display only
Select wide/ narrow clarifier range	MEM-UP	±2.5 kHz or ±1.25 kHz
Adjust Repeater Shift (0 to 500 kHz, <i>100 kHz default</i>). Press FM again after setting.	FM	Shift is displayed. Use tuning knob or DOWN/UP to change in 1-kHz steps.
Select normal/reverse carrier point (sideband) for CW reception	CW/N	Toggles LSB offset for CW reception (<i>USB</i> default).
<i>Display/ hide</i> memory channel display during VFO operation	VFO ► M	Affects display only
Clear All Memories and return settings to factory defaults	MEM-[DOWN + UP]	VFOs and Memory 1 default to 7.000 MHz LSB.
Scan Resume Mode: Always after 5-sec pause, or <i>only after squelch closes</i> .	SCAN	There is always a pause after squelch closes before scanning resumes.
Select Lock Mode: <i>Tuning Knob Only</i> , or Knob & Buttons	LOCK	"Lock" displayed when buttons are locked. MOX and POWER cannot be locked.

FAST Button Combinations	Hold FAST button and press...	Comments
Set Beeper Audio Frequency (310 to 1700 Hz, <i>880-Hz default</i>). Press AM/N again when done.	AM/N	Repeating double beep sounds and beep frequency displayed in Hz while adjusting.
Display/set VFO/PMS scanning speed.	VFO/M	Scanning speed value adjustable from 1 ~ 200, <i>10</i> is default.
Display/Select CTCSS Tone Frequency (from standard tones, <i>default 88.5 Hz</i>). Press FM again when done.	FM	Displays tone frequency in Hz. Use tuning knob or DOWN/UP buttons to select.
Adjust BFO Carrier Offset fo CW mode.	CW/N	Adjust offset from 400~1000 Hz, CW sidetone also matches offset.
Tag Current Memory to be skipped when Memory Scanning (<i>skip/no-skip</i>)	SCAN	Affects only memory scanning. "SKIP" displayed when activated.

Operation

Getting Started Tutorial

While reading this chapter, refer to the fold-out photos of the panels for the locations and functions of the controls and jacks.

Before plugging in the transceiver the first time, make sure your supply voltage is correct, and that your ground and antenna are connected as described in the *Installation* chapter. Then preset the following controls:

POWER & MOX switches: off (■);
MIC, RF PWR, SQL: all ccw (minimum);
AF: 10 o'clock;
CLAR: off;
SHIFT: 12 o'clock.

Connect your microphone and/or CW key or keyer, and then press the **POWER** switch on. The meter and display should light up.

At the left side of the panel, if the **ATT** or **PROC** button are depressed, press to turn them off.

Take a moment to study the display. You should see "VFO-A" or "VFO-B" at the left, with the operating frequency in large digits in the center (if you don't see a VFO indicator, press the **VFO/M** button near the top right). At the right side of the display is a small 2-digit memory channel number ("0" by default).



Use the **BAND- DOWN/UP** buttons (to the right of the tuning knob) to select a band for which your antenna is designed. These buttons have several different functions:

- By default (the *ham stepping* mode), when receiving on a VFO, these step from one ham band to another. Changing bands stores the current frequency automatically, so that **DOWN** and **UP** always return you to the frequency last used on each band (if it is inside the 500-kHz range of the ham band). The 10-meter band has two 1-MHz ham bands (see table above-right).
- If the **HAM/GEN** button has been pressed (to activate *GENeral coverage tuning* mode), "GEN" appears to the left of the frequency on the display, and the **DOWN** and **UP** buttons step in 100-kHz increments (or 1-MHz if **FAST** tuning is activated as described next).

Full details of all of the **DOWN** and **UP** buttons are shown in the table at the bottom of page 24.

Ham Bands

Meter Band	Frequency Range (MHz)
160	1.800 ~ 2.000
80	3.500 ~ 4.000
40	7.000 ~ 7.500
30	10.000 ~ 10.500
20	14.000 ~ 14.500
17	18.000 ~ 18.500
15	21.000 ~ 21.500
12	24.500 ~ 25.000
10	28.000 ~ 29.700

Example: say you're tuned to 7.000 MHz, and want to change to 21.200 MHz.

- First check to see if "GEN" appears on the left side of the display. If so, press the **HAM/GEN** button.
- Then press the **UP** button 4 times to change to the last-used frequency on the 15-meter band.
- Now you can use the tuning knob to tune to 21.200. However, if the current frequency is more than 100 kHz away, you can save some cranking: press **HAM/GEN** again so that "GEN" appears, and press the **DOWN** and **UP** buttons, as needed, to get within 100 kHz. Then use the tuning knob. When you want to change bands again, remember to press **HAM/GEN** so that "GEN" disappears.

Press the mode button (to the left of the tuning knob) corresponding to the mode you wish to operate — for now, we suggest an SSB mode: **USB** if you have selected a band above 10 MHz, or **LSB** otherwise. The selected mode is indicated above the frequency on the LCD.

Adjust the **AF** control for a comfortable volume level, then tune around the band a bit with the tuning knob to get the feel of it (if you want to adjust the torque, see page 23. For faster (×10) tuning steps, press the **FAST** button at the lower left side of the knob, to enable the "FAST" indicator below the MHz digits on the display.

Blanking the 10's-of-Hz Digit

If you prefer to have the 10's-of-Hz digit hidden on the frequency display, you can toggle display of this digit off and on by holding the **BAND- UP** button while switching the set on. Repeat this process to blank the digit. Tuning steps are not affected.

Tuning & Scanning Steps

Control ↓	Mode ⇒	LSB, USB, CW	AM & FM
Tuning knob, Mic UP/DWN Keys	Normal	10 Hz	100 Hz
	w/FAST button	100 Hz	1 kHz
DOWN/UP buttons	Normal	100 kHz	100 kHz
	w/FAST button	1 MHz	1 MHz
One rev of tuning knob*	Normal	10 kHz	100 kHz
	w/FAST button	100 kHz	1 MHz

* To halve knob tuning rate, move slide switch S2003

The **FAST** key normally toggles (press on/press off), but if you hold it while switching the FT-840 on, it becomes momentary, and you have to hold it while you tune. The table shown above lists all available tuning steps in each mode. If your microphone has **UP** and **DWN** buttons, you can use them to tune in 10- or 100-Hz steps. Also, the **FAST** button on the microphone duplicates the **FAST** button on the front panel.

General Coverage Reception

You may have already noticed that you can tune outside one of the amateur bands (actually, outside the 500-kHz segment that includes each ham band) regardless of whether **GEN** or ham-stepping is se-

Halving the Tuning Rate

The FT-840 default tuning rates are listed in the table above, and are selected using the **FAST** button. To halve the tuning rate (kHz per tuning knob revolution) for all modes, move slide switch S2003, accessible through the small hole on the bottom panel as shown below. Use a long non-metallic object to slide the switch. Tuning step size is not affected.

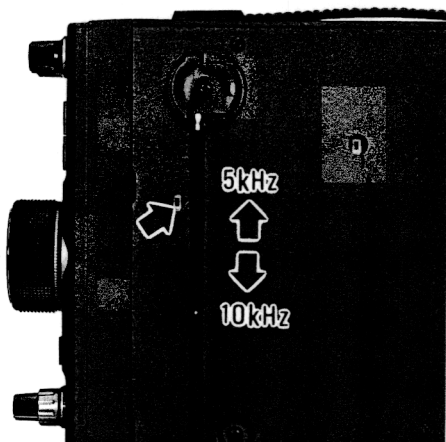

10- or 20-Hz Steps in AM & FM Modes

When changing modes from SSB or CW to AM or FM, operation initially remains on the same frequency, even if it is not a multiple of 100 Hz. As soon as you tune, the operating frequency jumps up or down to the nearest whole 100-Hz step. However, the clarifier can tune in 10- or 20-Hz steps (selectable) in all modes, so if you need fine tuning resolution in AM or FM mode, activate the clarifier (see page 22).

lected for the **BAND-DOWN** and **UP** buttons. However, the transmitter (and antenna tuner) are disabled on such frequencies. If you try to transmit, the indicator still appears, but there is no RF power output.

Also, the ham band recall system ignores such frequencies. If you select a ham band and then tune outside the band, the non-ham frequency will be lost when you change bands. When you return to the original band you will find that it has reverted to the (ham-band) frequency it was on when that band was previously selected.

Don't let this worry you: any displayed frequency can always be stored in a memory (as described on page 24) so you can recall it quickly later. Once you become familiar with the memories, you will find this convenient: each memory can be tuned just like a VFO, and stored again without having to go through the VFO.

Besides the above, general coverage reception provides all the features available on ham frequencies, and is also an interesting source of international music, news and entertainment. A table of international Shortwave broadcast bands is provided for your reference.

Shortwave Broadcast Bands

Meter Band	Freq. (MHz)	Meter Band	Freq. (MHz)
LW	.150-.285	31	9.35-9.90
MW	.520-1.625	25	11.55-12.05
120	2.300-2.495	21	13.60-13.90
90	3.20-3.40	19	15.10-15.70
75	3.90-4.00	16	17.55-17.90
60	4.75-5.20	-	18.90-19.30
49	5.85-6.20	13	21.45-21.85
41	7.10-7.75	11	25.67-26.10

Dealing with Interference

The FT-840 includes special features to suppress the many types of interference you may encounter on the HF bands. Still, real-world conditions are constantly changing, so optimum setting of the controls is somewhat of an art, requiring familiarity with the types of interference and the subtle effects of some controls. Therefore the following information should be considered only as general guidelines for typical situations, and a starting point for your own experimentation.

The controls are described in the order that you would usually make them after changing bands. An exception to this is if strong pulse noise is present, in which case you may need to activate the noise blanker (described below) before making other adjustments. Two special features, "Reverse CW Sideband" and "BFO Carrier Offset," are described later in the CW Operation section.

Attenuation

The FT-840 receiver front end provides high sensitivity to weak signals. A 12-dB attenuator can be inserted by pressing the **ATT** button.

When looking for weak signals on a quiet band, the **ATT** button should be switched off for maximum sensitivity. This situation is typical during quiet times on frequencies above 20 MHz, and when using a small antenna on other bands.

If you notice intermodulation, or if the signals you want to listen to are very strong, you can press the **ATT** button. This reduces the strength of all signals (and noise) by 12-dB (about 2 S-units), and can make reception more comfortable, important especially in long QSOs.

AGC-F (Automatic Gain Control - Fast Recovery) Selection

When tuning around the band looking for signals, the **AGC-F** button is usually best kept on (—), so receiver gain recovers quickly after tuning past strong signals. Once a signal is tuned in, unless it is

Locking the Dial or Buttons

Normally, pressing the **LOCK** button disables only the tuning knob (it still turns, but does nothing). If you wish to have it also disable the buttons (except itself, **MOX** and **METER**), turn the set off and then hold it while switching back on. Use this feature to prevent accidental changes to your settings.

very weak, you should find reception more comfortable with slow AGC (■).

Noise Blanker Setting

The noise blanker circuit in the FT-840 can blank both wide and narrow pulses, and can sometimes also reduce the level of static crashes from electrical storms. Pressing the **NB** button activates the blanker. If you hear pulse noise, just press in the **NB** button. If the blanker seems to distort a signal you're listening to, leave it off for optimum readability.

IF Shift Adjustment

(not used in AM & FM modes)

Once you have tuned in a signal you are going to listen to for a while, if you hear interference from nearby frequencies, use the **SHIFT** control to suppress the interference. Turning the **SHIFT** control left or right from center shifts the center frequency lower or higher, as depicted here.

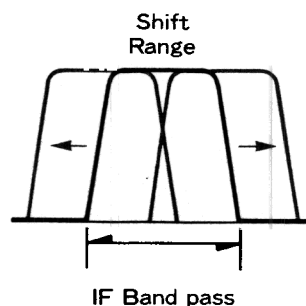

You will want to press the **LOCK** button beneath the tuning knob ("**LOCK**" displayed) before adjusting the **SHIFT** control, as accidentally retuning would invalidate your setting (particularly in narrow-bandwidth CW). When ready to retune to a new frequency, press **LOCK** again to release it, and return the **SHIFT** control to its normal position (centered).

AM & CW Narrow IF filters

Pressing the **AMN** mode button once (when switching from another mode), selects 100-Hz tuning steps and the 2.4-kHz narrow AM bandwidth. For weaker AM signals, or where adjacent channel interference is present, this narrow IF bandwidth offers a compromise between interference rejection and fidelity. For better AM reception, the optional YF-112A wide crystal filter can be installed. This gives the highest fidelity, and is best on strong AM

broadcasts (and particularly music). After installation, this will automatically be selected when pressing **AM/N**. The narrow 2.4-kHz filter can then be selected by pressing the **AM/N** button a second time ("**NAR**" appears at the top of the display).

For even better reception of AM signals under these conditions, you can switch to an SSB mode (whichever sideband gives the clearest reception). Along with the choice of the best sideband, you gain several benefits of the **SHIFT** control. After selecting the best sideband (LSB or USB mode), you need to zero beat the carrier to avoid distortion: turn the **SHIFT** control all the way clockwise for LSB or counterclockwise for USB, fine tune until the signal sounds steady and natural, then return the **SHIFT** control to center (or for best audio and interference suppression).

Pressing the **CW/N** mode button once selects the standard 2.4-kHz IF bandwidth, also used for SSB. With the optional YF-112C 500-Hz narrow IF filter installed, pressing the **CW/N** button a second time selects this filter, with "**NAR**" appearing at the top of the display. The 2.4-kHz bandwidth is often convenient to give a "wide view" when tuning around, but once you find a signal of interest and center it in the passband, the narrow selection optimizes selectivity. The next section on transmission gives more details of CW operation.

Transmitting

The FT-840 can transmit within the 500-kHz segments of the HF amateur bands above 1.8 MHz, and from 28 to 30 MHz. When tuned between 1.5 and 1.8 MHz, the tuner will not function, and when tuned to any other (general coverage) frequency,

Button Beeper Settings

Pressing a front panel button normally causes a beep to sound. Its volume is independent of receiver volume, and can be set by adjusting the **SIDE TONE** trimpot on the rear panel.

If you wish to change the pitch of the beeper, hold the **FAST** button (right of the tuning knob) while pressing the **AM/N** button. This causes the display to show the beeper frequency in Hz, while double beeps sound. Turning the **DIAL** knob adjusts the beep pitch (310 ~ 1700 Hz). When done, press the **AM/N** button again to return to normal operation.

You can also disable (or re-enable) the beeper by holding the **A=B** button while switching the transceiver on.

the transmitter is disabled. Still, you should restrict your transmissions to those frequencies authorized by your license, and for which your antenna is designed.

Attempting to transmit out of band still causes the **TX** indicator to appear, but the transmitter provides no output. The transmitter is also temporarily inhibited when stopping scanning (described later), as pressing the **PTT** switch while scanning just causes the scanner to stop.

When you transmit on an amateur band, the FT-840 senses reflected power at the antenna jack. If an impedance mismatch causes too much reflected power, the transmitter reduces power output to a nominal level (about 5 watts). Although this should prevent damage to the transceiver, we still recommend that you *do not transmit without having a proper antenna connected to the antenna jack.*

Automatic Antenna Matching

The external FC-10 & FC-800 automatic antenna tuners makes even first-time transmitter setup very simple. After using the tuner once on a band, it recalls previous settings from memory (the tuner has 31 of its own) during reception, whenever you tune to the same part of the band again. When using the tuner the first time on an antenna, we recommend you set the **RF PWR** control to around the 12-o'clock position or greater to maintain at least 10-watts available for the tuning process. All you have to do beforehand is ensure your transmit frequency is clear of other signals. If you want to monitor the tuner's action, press the **METER** button (**PO** position).

If "**SPLIT**" is displayed to the left of the frequency, press the **SPLIT** button near the top right to disable split operation for now.

After making sure you are on a valid transmitting frequency, and that the channel is clear of other signals, press the **START** button near the upper right corner of the front panel. The "**TUNER**" indicator comes on, indicating the automatic tuner is activated, "**WAIT**" appears at the top right corner of the display, and the "**TX**" indicator at the left end of the display lights while the tuner seeks the proper matching settings.

If monitoring SWR on an external meter, you should see the tuner select the lowest possible reading. When the "**WAIT**" indication on the display turns off (usually less than 30 seconds), you are ready to transmit (assuming the "**HI SWR**" indicator didn't come on).

Once you have used the antenna tuner, the "TUNER" indicator remains on (unless you press the TUNER button to switch the tuner off). If the tuner found a match, the "WAIT" indicator will occasionally flash when you change frequency (while receiving), as the main microprocessor reports the frequency change to the tuner coprocessor (reception is unaffected). The tuner coprocessor compares the current frequency with its memories, and rematches the antenna to the new range if it has any previously stored settings for that range. However, when you first connect a new antenna, the tuner does not have the correct settings stored in these memories, so you need to "train" the tuner, by pressing the START button whenever you change to a new frequency range.

Important!

When using the FC-10, if the "HI SWR" indicator appears at any time, the tuner is unable to match your antenna at the displayed frequency. You will have to tune to another frequency, or repair or replace your antenna or feed line.

SSB Operation

To transmit in LSB or USB mode:

- Make sure the appropriate mode indicator above the frequency read-out appears, and ensure that the METER button is in the undepressed (■ ALC) position. The meter now shows automatic level control voltage when you transmit. This is negative feedback to the transmitter amplifiers that prevents overdriving the finals (higher ALC indicates greater reduction of RF amplification).
- If this is the first time you are transmitting SSB with the FT-840, preset the MIC control to about 12 o'clock, and the RF PWR control fully clockwise.
- Confirm that the display shows the frequency you want to transmit on.
- Listen carefully on the frequency to make sure you will not interfere with any other stations. Then, if you have an automatic antenna tuner option, press START to match the antenna.
- After "WAIT" disappears from the display, press the PTT (push-to-talk) switch on your microphone, and give your callsign (to identify your transmission) or make your call. You should see the meter fluctuate as you speak.

Note: Adjusting the MIC control for proper ALC indication on the meter requires that the SWR be

below 1.5:1. Otherwise the ALC meter may behave erratically.

- To find the optimum setting of the MIC control for your microphone, begin with it fully counterclockwise (minimum), and adjust it while the RF PWR control is fully clockwise. Speak into the microphone (at a normal level) so that the meter deflects no further than mid-range (the upper end of the blue ALC range) on voice peaks. This will normally be about the 10-o'clock position with the MH-1B8 or MD-1C8 microphone.
- You can press the METER button (— PO position) and adjust the RF PWR control for less output power, as indicated on the center meter scale. We recommend using the lowest power output possible to maintain reliable communications — not only as a courtesy to other stations, but to minimize power consumption and the possibility of causing RFI and TVI, and to maximize the life of the equipment.

Microphone Tone Selection

Before setting up the speech processor, set the selector switch on your microphone for the desired audio characteristic. The higher-numbered setting(s) suppress low frequencies. See page 5.

AF Speech Compressor

Once you have found the proper MIC control setting (with full power) and selected the microphone tone characteristic, you can activate the speech compressor to increase the average power of your signal. The RF PWR setting does not affect speech processor adjustment.

- With the METER button set for ALC (■ ALC position), press the PROC button below and to the right. Now speak into the microphone and adjust the MIC control slightly, if necessary, so the meter needle stays within the thick blue ALC zone on the bottom scale.
- The COMP control on the rear panel (the shaft nearest the red 13.5 V DC jack) sets the degree of compression. This control is preset to the 12-o'clock position at the factory, which provides about 10 dB of speech compression with an average voice pitch. Setting it for more compression can seriously distort your signal, so it should only be adjusted if you have some means of monitoring the transmitter. You can do this with an external receiver, if you have one, or by having another station give you signal reports as you adjust it.
- If you adjust the COMP control, you should recheck your MIC control setting as described in the step before last.

CW Operation

CW transmission with the FT-840 requires that you have a CW straight key or electronic keyer unit connected to the **KEY** jack on the rear panel. There are no critical adjustments for the transmitter: you just use the **RF PWR** control to set your output power.

- With the CW mode selected, begin by pressing the **METER** button (— **PO** position).
- Now you can adjust the **RF PWR** control for the desired power output. Note that if you select less than maximum power output and set the **METER** button to the — **ALC** position, the meter will deflect beyond the ALC zone. This is perfectly normal, and does not indicate a degraded signal.
- Release the key to return to receive.

Courtesy of the internal circuitry, you are now using semi break-in CW, in which the transmitter remains keyed except during pauses in your sending. You can set the “hang time” during which the transmitter remains on after you stop sending, by adjusting the **DELAY** trimpot on the rear panel (see *Rear Panel Connections*).

Reverse CW Sideband

When you switch modes between CW and USB, you may notice that the frequency of the received signal stays the same (even though the panel frequency display may change slightly). Also notice that in both CW and USB, the pitch of a received signal *decreases* as you *increase* the dial frequency.

However, switching between LSB and CW normally requires retuning the desired signal. This can be especially inconvenient if you enjoy working the lower HF bands (40 meters and below) where LSB mode is used.

CW Pitch and Sidetone Monitor

In the FT-840, the BFO offset (or CW “pitch” as it is sometimes called) can be varied from 400~1000 Hz (700 Hz default). This means a CW signal tuned for a pitch corresponding to this offset will be centered in your receiver’s IF passband.

The displayed frequency offset for CW mode, and the sidetone heard from the speaker while your CW key is closed, are also adjusted to match the BFO offset. If you are using a multi-mode TNC or CW decoder, you will want to set the BFO offset to match that used by your unit (some multi-mode controllers require an 800-Hz pitch for optimum CW reception).

To change the CW offset and sidetone, hold the **FAST** button while pressing the **CW/N** key, to display the current offset (“pitch”).

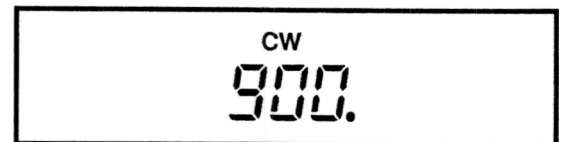

You can then use the **DIAL** knob or **BAND-UP/DOWN** keys to select the desired offset. Press **CW/N** again to save the entry and return to the normal display.

Note: sidetone volume can be adjusted using the small trimpot labeled “**SIDE TONE**” on the rear panel.

As an operating convenience to eliminate the need for retuning in this situation, the receiver CW carrier injection side can be switched to the high-side (same as used for LSB mode) by holding the

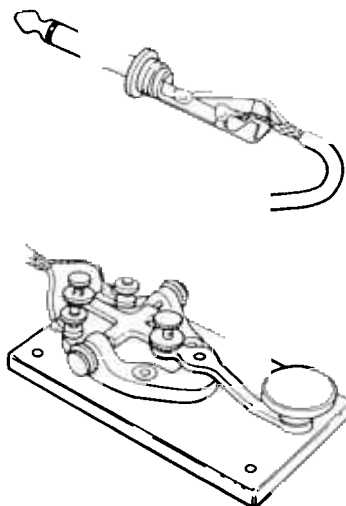

CW Key Connections

Operation

CW/N button while turning the transceiver on. When using the "reverse" sideband for CW reception, you can freely switch between LSB and CW after tuning a desired station without having to re-tune. Note that in LSB and CW modes the received signal pitch now *increases* with dial frequency (a good way to confirm you are using the reverse sideband). To return the receiver to the default (upper) sideband for CW reception, repeat the power-on sequence (**POWER + CW/N** key).

An important benefit also realized from this feature is QRM rejection. If you are experiencing QRM on a CW station, try using the "reverse" sideband and re-tuning the signal.

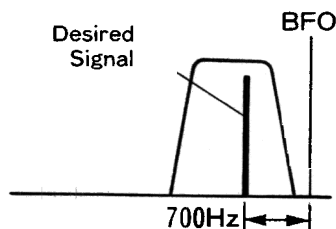
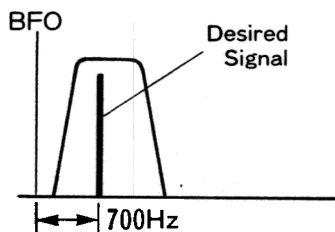

Reverse CW Sideband Operation

AM Transmission

Transmitter output power in the AM mode is limited to 25 watts (carrier), and attempting to adjust it for a higher level will have no effect. After setting the power level, you may need to adjust the **MIC** control to avoid over-modulating. This setting will be lower than the optimum SSB setting.

- The speech processor can be used in the AM mode, but for now, make sure the **PROC** button is off, so as not to confuse adjustments.
- With the **AM** mode selected, press the **METER** button (**— PO** position). Squeeze the PTT and rotate the **RF PWR** control for the desired level (remember transmitter power output is limited to 25 watts in the AM mode).

- While speaking into the microphone, adjust the **MIC** control just to the point where the meter *begins to deflect slightly*. Do not set the **MIC** control further clockwise than this, or your signal will be distorted.
- Reduce the **RF PWR** control, as necessary, for the desired output level.

Carrier Offset Display

When changing between SSB and CW modes the displayed frequency will normally change by an amount determined by the BFO (carrier) offset for each particular mode (1.5 kHz for SSB and 700 Hz for CW, for example).

If you prefer the frequency display to *remain the same* when switching modes, hold the **BAND-DOWN** button while turning the set on. The display will now show your true (suppressed) carrier frequency (without reflecting the BFO offset). Repeat this step to return to the default display.

FM Transmission

For FM transmission, the only control to be concerned about is **RF PWR**. Microphone gain for FM is preset internally and normally needs no adjustment after leaving the factory. Just set the **METER** selector to the **— PO** position, and adjust the **RF PWR** control for the desired output while transmitting. To avoid overheating, if you need full power, keep your transmissions to *three minutes or less*, with the same time for reception.

FM Repeater Operation

The FT-840 includes several features specifically intended for operation on FM repeaters above 29 MHz. To locate these repeaters, you can ask around the calling channel (29.6 MHz), or try 20-kHz frequency multiples from 29.62 to 29.68 MHz.

When you find a repeater, press the **FM** button once for "–" shift (to transmit below your receiving frequency), "**— TONE**" will also appear, indicating the subaudible CTCSS tone encoder is automatically activated. Pressing **FM** again selects "+" shift, but this is not commonly used above 29.6 MHz. Press it once more to return to simplex.

Try a quick ID transmission to make sure you have the shift right (by default, the FT-840 also automatically transmits a low-level 88.5-Hz

subaudible tone during FM Repeater transmissions, to access repeaters that require it).

After you make contact through a repeater, you can store frequency, mode and repeater shift/CTCSS settings in memory (page 24) for later recall.

If a repeater uses an offset other than the standard 100 kHz, you can change the FT-840 offset by turning it off and then back on while holding the **FM** button. This displays the offset, which can be set between 0 and 500 kHz using the tuning knob (see below). Press **FM** once more when done.



If you find a repeater that requires a CTCSS tone other than 88.5 Hz, you can select another tone by holding the **FAST** button while pressing **FM**, turning the tuning knob, and pressing **FM** again (to accept).

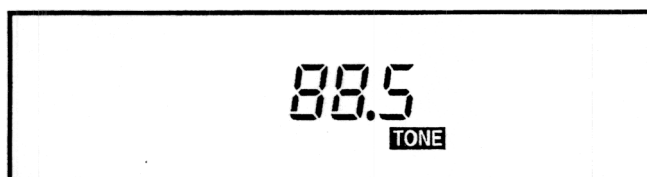

The tone you select applies only to the current VFO, but can be stored in memory.

CTCSS Tones (Hz)				
67.0	100.0	131.8	173.8	218.1
71.9	103.5	136.5	179.9	225.7
77.0	107.2	141.3	186.2	233.6
82.5	118.8	146.2	192.8	241.8
88.5	123.0	151.4	203.5	250.3
94.8	127.3	162.2	210.7	

Clarifier (Receiver Offset Tuning)

The **CLAR** button and knob near the upper-right side of the front panel let you offset the receiving frequency ± 1.25 kHz from that originally displayed (and used for transmission), in 10-Hz steps (see box).

Perform the following steps, if you like, to familiarize yourself with the clarifier controls:

- Press the **CLAR** button and notice that "**CLAR**" appears at the bottom right of the display. If any clarifier offset has been tuned before, the frequency display shifts accordingly. Turn the **CLAR** knob and notice that the frequency display changes. Now press the **CLAR** button again several times: the operating frequency returns to its "unclarified" setting when the clarifier is off, and adds the offset (to the receive frequency only) when the clarifier is on.
- With the clarifier on, press the PTT switch and notice that the transmit frequency remains the same as the original (that is, non-offset) frequency display.

A typical application for the clarifier is when you are in contact with a station whose transmitter drifts (or perhaps you were not both precisely tuned to the same frequency when you started). You don't want to change your transmitting frequency, as that would force them to retune — you just want to adjust your receiver. To do this, you can press the **CLAR** button to activate the clarifier, and carefully retune their signal with the **CLAR** knob.

After you finish your conversation, you must remember to press the **CLAR** button again to turn off the clarifier. You also might want to clear the offset (by adjusting the **CLAR** knob) before turning it off.

Clarifier Range & Display Options

The default clarifier tuning range (± 1.25 kHz in 10-Hz steps) can be *doubled* to ± 2.50 kHz (in 20-Hz steps) by holding the **MEM-UP** key while turning the transceiver on. To turn the **CLAR** rx offset display on/off, hold the **CLAR** key while powering the radio on. Repeat the above steps to toggle the functions and return to default settings

VFO B & Split Frequency Operation

VFO-B works exactly like **VFO-A**, although each is totally independent of the other. You can use **VFO-B** as a general-purpose "instant recall" memory. In the FT-840, **VFO-B** has two important purposes: to double memory storage capacity (described in the next section), and to facilitate split-frequency operation (receiving on one VFO, and transmitting on the other). The special case of

split-frequency FM repeater operation uses some features of its own, as described on the previous page. Also, if the difference in transmit and receive frequencies is less than 2.5 kHz, using the clarifier function is likely to be the easiest approach.

Use the **A/B**, **A=B**, **SPLIT** and **M► VFO** buttons at the right end of the display to set up the two VFOs:

- A/B** toggles operation between the two VFOs, without affecting the contents of either.
- A=B** copies the contents of the currently displayed **VFO-** (**A** or **B**) to the other (**B** or **A**, respectively), overwriting the contents of the non-displayed VFO.
- SPLIT** toggles the "hidden" VFO for transmission.
- M► VFO** copies the pair of frequencies stored in a memory into the VFOs, by pressing it for 1/2 second (until the double-beep sounds). This is described in the next section on memory storage and recall.

For split operation, you need to first load the VFOs with the desired transmit and receive frequencies and modes. Set your mode and frequency for transmission, then press **A/B** and set your mode and frequency for reception. You can use the **A/B** button to check your transmit frequency while re-

ceiving (to avoid transmitting unnecessarily). Once the two VFOs are set up, just press the **SPLIT** button. "SPLIT" appears in a box at the left edge of the display, and when you transmit, the display frequency shifts to the other VFO (and mode indicator, if different). The contents of both VFOs can be stored in a memory for future operation with the same frequency pair, as described next.

Memory Features

The 100 memories in the FT-840, labeled **01** through **90**, and **P1** through **P0**, each store a pair of frequencies and modes, plus wide/narrow IF selections (for CW and AM modes), clarifier on/off and offset settings, plus split frequency status. When you recall a memory, one set of these operating parameters is displayed, and the other set is hidden. For simplicity, we will refer to the displayed set of parameters as the *front half* of the memory, and the hidden set as the *rear half*. The front and rear halves can be toggled by the **A/B** button, just as you can toggle **VFO-A** and **VFO-B** when operating on a VFO (although the display gives no indication of which half is which, as it does with the VFOs). Like VFO operation, you can operate split with the two halves, receiving on the front and transmitting on the rear; and you can

Tuning Knob Torque Adjustment

If the tuning knob is too tight or too loose for your preference, and if you have a 2-mm (5/64") Allen wrench, you can adjust the torque.

- Pull the knurled rubber ring off of the tuning knob.
- Locate the hole in the edge of the tuning knob, and use the Allen wrench to loosen the set

screw accessible through the hole, just enough to allow the knob to be pulled off the shaft.

- Turn the exposed shaft tension spring counter-clockwise to loosen the torque, or clockwise to tighten.
- Replace the knob, tighten the set screw, and replace the rubber ring.

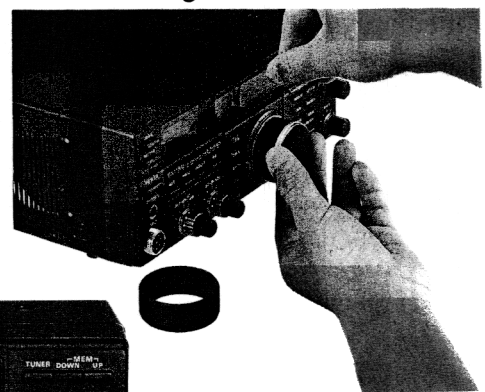
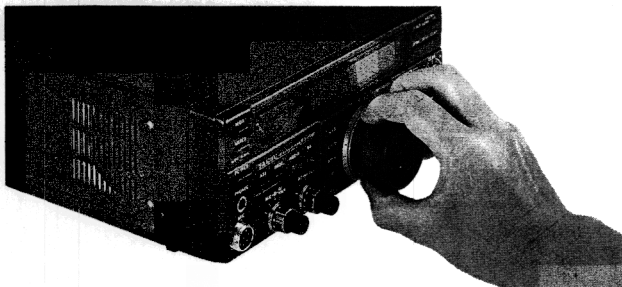

Operation

freely tune and change the mode or clarifier settings of whichever half is displayed while receiving. You can also copy a pair of settings from one memory to another. In fact, you can do nearly anything with the two halves of a memory that you can with the A/B VFOs, except for a few differences in tuning steps, scanning (only the front can be scanned) and special-purpose memories P1~P3, described later.

Memory Storage

The FT-840 enables you to store the settings of one or both VFOs into the memory channel (front and rear halves) indicated by small numbers at the right of the display. To store only the displayed VFO, just press and hold the **VFO►M** button for ½ second (two beeps sound). The front half of the memory will contain your entry, while the rear half holds any previous entry (or the factory default setting of 7.000 MHz).

To copy the contents of both VFOs (A and B) into both "halves" of the current memory number, first press the **SPLIT** button ("**SPLIT**" displayed) before holding the **VFO►M** button as before. We'll begin with a simple example of storing only the currently displayed frequency into the front half of a memory (we'll describe how to store the non-displayed VFO in the rear half later).

Example: to store 14.250 MHz from a VFO into memory 10.

- First press **VFO/M**, if necessary, so that either "**VFO-A**" or "**VFO-B**" appears at the left. Select the desired mode, then tune the display to the desired frequency (14.250.00) using the **HAM/GEN** and **BAND-DOWN/UP** buttons to change bands and tune in 100-kHz steps, and then the tuning knob as needed.
- Next press the **MEM-DOWN** or **UP** buttons momentarily so that "**MEM**" appears blinking in the

lower left of the frequency display, and within 3 seconds use the **MEM-DOWN** or **UP** buttons to step through the memory channels until "10" (the desired memory) appears in small digits at the far right. If nothing was stored there before, the frequency display will be blank (as shown).

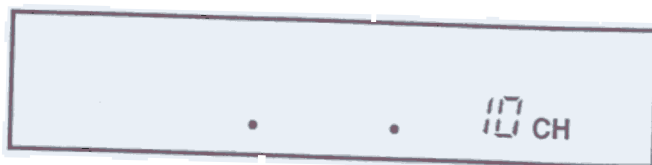

- Now hold the **VFO►M** button for ½-second until two beeps sound. To confirm the entry was stored, you can press the **VFO/M** button to display the memory (below).

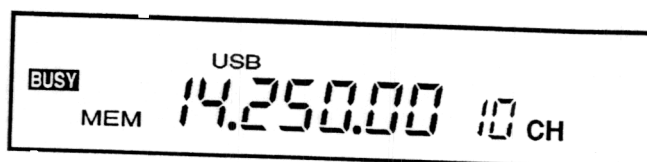

Although we ignored it, keep in mind that when we stored the displayed VFO, the hidden one was not stored in the rear half of the same memory. You could have pressed the **SPLIT** button after setting up both VFOs to the desired frequencies before storing them in a memory. Both are then written to memory, overwriting whatever may have been stored there previously. In addition, the clarifier on/off state and offset for both VFOs are also stored in the memory (whether or not the clarifier is activated).

Checking Memory Contents

Before storing or recalling a memory, you will usually want to check its contents. If you are operating on a VFO, you can of course just press **VFO/M** to recall the last-used memory, but this has disadvantages: any current operation is interrupted as

Panel & Microphone DOWN/UP Key Functions

MODE	Front panel BAND-[DOWN▼/UP▲] key	Front panel MEM-[DOWN/UP] key	Mic. UP/DWN key
VFO-A or VFO-B	HAM mode: HAM band stepping GEN mode: 100 kHz/1 MHz steps	enters memory-check mode ("MEM" indicator blinks) steps mem. channels up/down	duplicates main DIAL for VFO tuning VFO scanning**
MEM	M-TUNE VFO-A or VFO-B	memory channel stepping (up/down)	memory ch. stepping Memory scanning**
M-TUNE	same as VFO-A or VFO-B	enters memory-check mode ("MEM" indicator blinks) steps mem. channels up/down	duplicates main DIAL for memory frequency tuning
PMS	same as VFO-A or VFO-B		Same as MEM key

** press and hold the microphone **UP/DWN** key (> ½ sec.) to begin scanning.

your frequency changes, the antenna tuner retunes (if installed), and you'll have to press **VFO/M** again to get back to the VFO. Also, this will not work if you are operating on a re-tuned memory: you will lose any changed settings entirely! So, the FT-840 offers a way to display the (front) contents of memories without affecting current VFO (or re-tuned memory) operation, and requiring only one key press. We call it *memory checking*, and you already did it in the preceding example.

You activate memory checking by momentarily pressing either the **VFO►M**, **M►VFO** or **MEM-DOWN/UP** buttons. As you saw above, "MEM" blinks at the left of the display as the frequency and mode indicators change to show the contents of the last-selected memory. If you touch nothing else, the display reverts to your current operating parameters automatically after 3 seconds. By pressing the front panel **MEM-DOWN** or **UP** buttons before the 3 seconds expires, you can select for display the front half of each of the 100 memories. Pressing these buttons restarts the 3-second timer, so as long as you are changing channels, memory checking mode persists.

While checking memories, the memory number shows at the right end of the display (instead of the 10-Hz frequency digit, if you have it enabled). Also, when you select a vacant memory, the mode indicators and frequency display go blank (except the decimals).

Still, memory checking does not show you everything you've stored; it only shows the visible *front half* of the memory. To display the frequency, mode and clarifier settings stored from the other VFO you have to recall the memory and press the **A/B** button. So, when storing memories with the intention of using both halves (front and rear), it is a good idea to have them related in some way so that you can recognize both later when only the contents of the front half appear.

Memory Recall & Operation

To recall data stored in a memory for operation, you can either copy it into the VFOs, or you can switch operation from the VFOs to the memories. Since you can freely tune any memory, copying it to the VFOs only gives you the advantage of **VFO-A** or **VFO-B** display indication.

Holding the **M►VFO** button for ½ second copies the current memory channel data into the VFOs. Pressing it only momentarily shows you the contents of the memory, without actually overwriting the VFO data. Otherwise, when you press and hold this button, you lose the previous contents of both VFOs, and if you were receiving on a VFO,

Frequency Display Modes

VFO display with 10-Hz digit activated (page 15)



Press **VFO/M** to switch to MEM mode.

MEM mode display of memory 10 with same frequency:

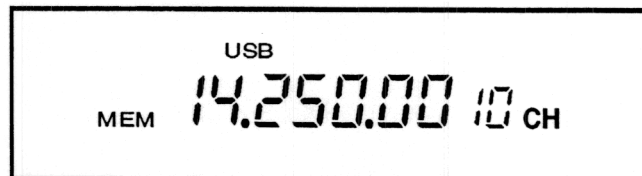

Touch the tuning knob or microphone **UP/DWN** button to switch to M-TUNE mode:

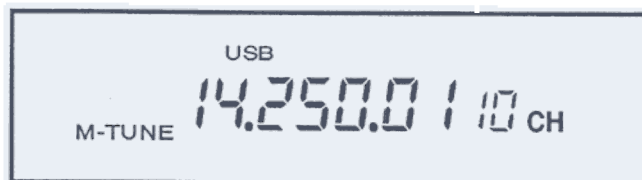

M-TUNE mode display of re-tuned memory 10 (+10 Hz). Press **VFO/M** once to cancel changes and revert to MEM mode, and press it again to return to VFO mode.

operation shifts to the frequency and mode copied from the memory (and now in the VFO).

In most situations you may find it more convenient simply to switch operation from the VFO to the memory, by pressing the **VFO/M** button. This method allows you to leave any settings in the VFOs undisturbed, so you can instantly recall them just by pressing **VFO/M** again.

When actually operating on a memory (if you haven't re-tuned it), "MEM" is displayed at the left (instead of "VFO-A" or "VFO-B"), and you can press the **DOWN/UP** buttons on the panel (or the microphone buttons) to select any previously stored memory for operation. You cannot activate mem-

Memory Channel Display

In the default setting, the current memory channel selection is displayed at the lower right corner of the LCD during *both* VFO and memory operation. If you prefer to have the channel display only appear during memory operation, hold the **VFO►M** button while turning the transceiver on. Repeat the same procedure to cancel the change.

Operation

ory checking or copy the recalled memory directly to another memory, as the function of the **VFO ► M** button changes as described later under *Memory Blanking*.

However, there is an easy way to get this button to work the same as it does on the VFOs, and to regain the memory checking feature: if you change frequency, mode or clarifier settings, or if you press **A/B** to switch front and back halves, "MEM" on the display is replaced with "M TUNE". In this *memory tuning* mode, the functions of several buttons differ from the ordinary memory recall mode: the **DOWN/UP** buttons select ham bands or 100-kHz steps (as when operating on the VFOs), the microphone buttons duplicate the tuning knob function instead of the front panel **DOWN/UP** buttons, and the **VFO/M** button cancels any changes to the memory and returns you to the memory recall mode ("MEM" displayed again), instead of switching to the VFOs. See the table at the bottom of page 24 for the various function of the **DOWN/UP** buttons.

The memory tuning mode makes operation on memories 01 to 99 just as flexible as the VFOs. If you want to save changes to a memory channel, use the same procedure you use to store the VFOs to memory: Press **VFO ► M** momentarily and the **MEM-DOWN/UP** buttons to select another memory (if desired), or just hold **VFO ► M** for ½-second until the double beep sounds (to overwrite the current memory with the re-tuned data). The labeling of the **VFO ► M** button is somewhat deceptive here: the VFO settings, which are hidden at this point, are not involved in this operation at all, since those of the recalled memory have taken their place.

As mentioned above, if you just want to cancel any changes you have made to a recalled memory, press **VFO/M** once ("MEM" is displayed again), and press it again if you want to return to the VFOs. The display mode changes are summarized on the previous page.

Split operation can be enabled and stored in a memory, in which case the rear half of the memory is used for transmission. Similarly, pressing the **A/B**

button while receiving on a memory switches operation between the front and rear halves of the memory (don't forget both of these functions also activate memory tuning).

Scanning Features

After you have programmed several memory channels, you will probably want to scan them later to check for activity on those frequencies. The 100 memories in the FT-840 are organized into 10 groups, with 10 channels in each group (see below). You have several choices with regards to scanning these memories, and after the following brief explanation, you can determine which mode is best for your operating needs. There are two basic scan modes in the FT-840: *Memory Scan* or *Group Scan*. In addition, you can choose how scanning resumes: after either a *carrier-* or *time-delay*. Scan speed is also adjustable. Scanning features are summarized in the table on the next page.

Memory Scanning (normal)

Normal scanning sequentially checks all memories *programmed with data* (vacant or masked memories will be skipped over). Memory channels P1 ~ P9 have a dual purpose, and are used with the PMS (*Programmed Memory Scan*) feature explained later. However, they are still selected and scanned the same way as the other 90 memories. When receiving on a recalled memory (with "MEM" displayed), you can scan the front halves of all stored memories by *momentarily* pressing the **SCAN** button (< ½ sec.), or *holding* the microphone **DWN** or **UP** button for ½ second to start. If you want scanning to pause on signals, you must first adjust the **SQL** control to silence the receiver ("BUSY" indicator off) on a clear channel.

Scan Resume

When a signal strong enough to open the receiver squelch is found, scanning will pause on that channel, and the two decimal points on the frequency display will blink. By default, *carrier delay* scan is active and scanning will resume again

Memory Channel Organization

GROUP 1	GROUP 2	GROUP 3	GROUP 4.....GROUP 9	GROUP 10
ch-01~10	ch-11~20	ch-21~30	ch-31~40.....ch-81~90	ch-P1~P9

Memory Scanning

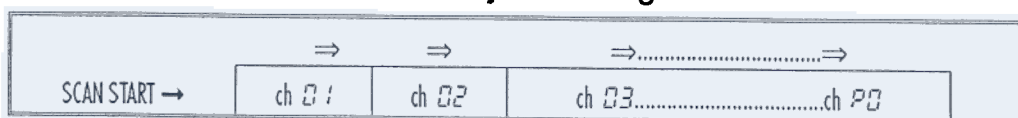

Scanning Feature Summary

Scan Mode/Feature	Description	Enabled by:
Channel Scanning (normal)	Sequentially scans up to 100 available memory channels (from $\text{CH } 1 \sim \text{PQ}$). Blanked memories or those marked for scan skip are passed over during the scanning sequence.	With any memory channel displayed, press SCAN momentarily ($< 1/2$ second).
Selected Group Scanning	Sequentially scans only those selected memory channels (max. 10) within a single selected group (blanked and scan skip rule still applies).	With any memory channel within the desired group displayed, press and hold SCAN $> 1/2$ second (two beeps sound).
Scan Resume Mode: Carrier Delay	Pauses on active memory channel, resumes 5 seconds after carrier drops	Hold SCAN button while turning the transceiver on to toggle between <i>carrier-time-delay</i> scan resume (<i>carrier-delay</i> is default).
Scan Resume Mode: Time Delay	Pauses on active memory channel for 5 secs., then resumes scanning.	
PMS (Programmed Memory Scan)	Stores up to ten upper and lower frequency limit pairs in special-purpose memories $\text{P } 1 \sim \text{PQ}$. Memory-tuning and scanning is then confined within these limits.	Program both VFO settings into the front and rear halves of any special-purpose memory ($\text{P } 1 \sim \text{PQ}$). Enable M-TUNE, then press the SCAN button to start/stop.
Scan Speed Adjust (for M-TUNE & PMS)	Adjusts scan speed for above modes, value ranges from 01 (fastest) \sim 200 (slowest). Default speed set at 10. FAST key function and tuning steps for each operating mode are not affected.	Press VFO/M while holding the FAST key.

English

shortly only after the signal (carrier) is no longer received.

Alternately, you can select *time-delay* scan by holding the **SCAN** button while turning the transceiver on. Scanning will continue to pause on an active channel as before, but immediately resume after 5 seconds have elapsed, regardless of any signal on that channel. Note that the memory channels can still be scanned even if the receiver is un-squelched (scanning will move from channel to channel, "sampling" each for 5 seconds. This is useful if you want to hear weak signals that otherwise might not be strong enough to open receiver squelch during *carrier-delay* scanning. To return to default carrier-delay scan resume, simply repeat the power-on procedure (**SCAN + POWER**).

Group Scan

This permits selecting any single channel-group (group 1 ~ group 10), and only scanning channels (up to 10) within that group. To perform a group scan, simply select *any memory channel within the desired group*, then press and hold the **SCAN** button for $1/2$ sec. (until two beeps sound). For example, selecting any memory channel from $\text{CH } 31 \sim \text{CH } 40$ will

result in scanning group 4 (see below). Group scanning is especially useful if you wish to organize your 100 memory channels into "blocks" of interest (i.e. group 1-FM repeater frequencies, group 2-SSB contest calling channels, group 3-AM broadcast frequencies, etc.).

In both scanning modes, you may need to readjust the **SQL** control to prevent scanning from stopping on only background noise.

To stop scanning, press **SCAN**, the PTT switch (no transmission will occur), or a microphone button again. When scanning, keep in mind that the **ATT** button also affects the squelch threshold.

Memory Scan Skip

Once you have stored many memories, you may not want to scan some of them. You can mark some of them to be skipped *during either Channel or Group Scanning* (see below). To do this, recall the memory to be skipped, and hold the **FAST** button below the left side of the tuning knob (or on the microphone) while pressing **SCAN** momentarily. The "SCAN" indicator disappears below the memory number at the right.

Group Scanning

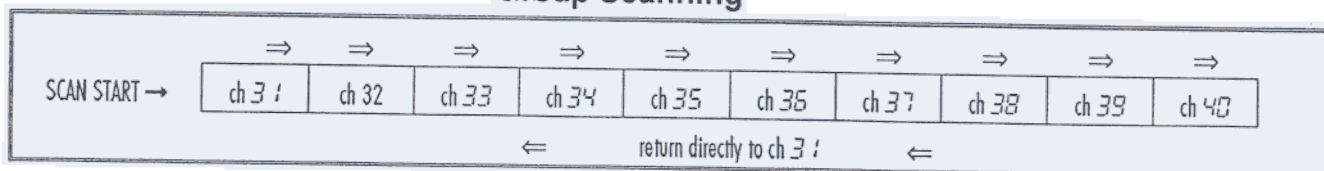

Operation

If you have set a memory to be skipped, and later want to include it, just repeat the **FAST + SCAN** procedure.

Memory Blanking

After storing many memories, you may want to completely hide some from normal operation, to simplify selection of the others. To blank a displayed memory, while "MEM" is displayed at the left of the frequency, press and hold the **VFO►M** button for ½-second until the double beep sounds. But be careful: if you do this instead while "M TUNE" is displayed — that is, after retuning the memory, the re-tuned data will overwrite the original memory data, but it will not be blanked. So, if you have re-tuned the memory and don't want to save the changes, cancel them first by pressing **VFO/M** once, and then hold **VFO►M** for ½ second.

While a memory is blanked, no frequency digits appear. As long as you don't overwrite a blanked memory, you can un-blank it simply by repeating the same procedure you used to blank it.

PMS Scanning:

Special-Purpose Memories P1 ~ P0

As you probably have noticed, when operating on a VFO or re-tuned memory, if you press **SCAN**, or hold either the **DWN** or **UP** button on the microphone for ½ second, scanning starts, and pressing one of these buttons again stops it. By setting the **SQL** control so that the receiver is just silenced on a clear frequency, scanning will pause when it finds a signal, and resume according to the *Scan Resume* selection described above under *Memory Scanning*.

You can also increase the scanning step size by 10, by pressing the **FAST** button while scanning (or

Scan Speed

VFO and PMS frequency scanning speed can be adjusted by pressing **VFO/M** while holding the **FAST** key.

Use the main **DIAL** knob to adjust the scan speed value from 01 (fastest) to 200 (slowest), (01 is the factory default). Press **VFO/M** to save your entry and return to the frequency display.

Note: frequency tuning steps for each mode and the **FAST** button function, described earlier, are not affected.

toggling it on, if you have set it to work that way — see page 16).

If you let scanning continue indefinitely, it will loop around when it reaches 100 kHz or 30 MHz, including the entire range of receiver coverage. To limit scanning to a particular frequency range, you will want to make use of the programmable scanning limit (we call it *PMS*) facility provided with the ten special-purpose memories: P1 ~ P0.

To limit the tuning range to a particular subband, store the upper and lower edge of the frequency range in the front-and rear-halves of one of memories P1 through P0. Then recall the desired memory and activate memory tuning. Tuning and scanning now loop around the ends of the stored range, keeping operation inside the programmed memory subband (see bottom of previous page).

You can change modes and use the clarifier as when retuning any other memory, but don't bother to press **A/B** to switch halves of the memory, or to press the **DOWN/UP** buttons: as soon as you try to tune with the knob or microphone buttons, operation instantly switches back to the subband. Also,

Memory Scan Skip

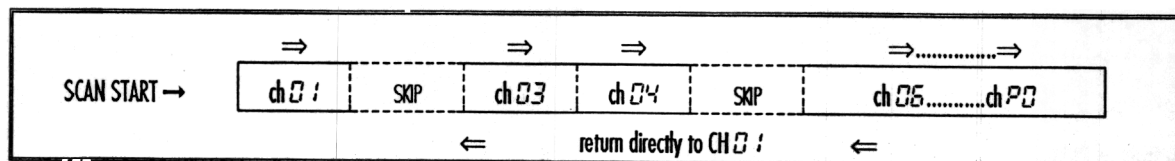

PMS Scanning and M-TUNE

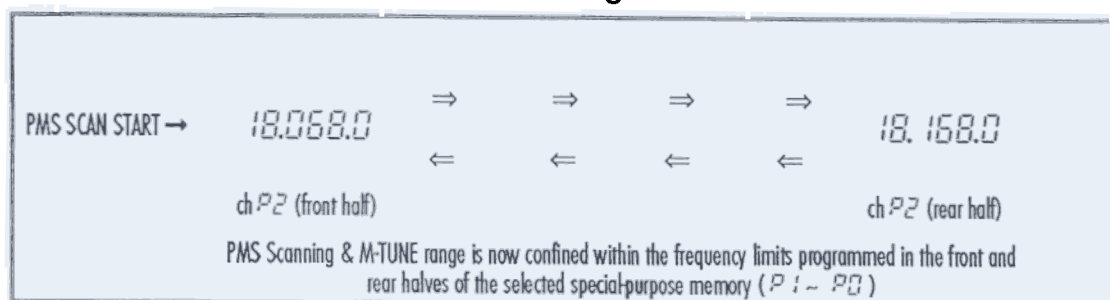

if you activate split transmit/receive, your transmit frequency will be whatever you stored in the back half of the memory you started on ($P 1 \sim P 9$).

Example: Use memory $P 2$ to limit memory-tuning and PMS scanning to the 17-m WARC band.

- Press **VFO/M** once or twice, if necessary, to display either "VFO-A" or "VFO-B" at the left. Then tune to the low edge of the 17-m band: 18.068 MHz. Also select the mode you expect to use most often (here, USB or CW).
- Press **A/B** to select the other VFO, and tune to the high edge of the 17-m band: 18.168 MHz. Again, select a mode you expect to use (it does not need to be the same), then press **SPLIT** (to select both VFOs).
- Press **VFO**►**M** momentarily to activate memory checking, and press the **DOWN/UP** buttons to select memory $P 2$ at the right, then hold **VFO**►**M** for ½ second to write the two VFOs into both front and rear memory halves.
- Press **VFO/M** to recall memory $P 2$, then *turn the tuning knob* (to activate memory tuning), or press the **SCAN** button.

Memory tuning and scanning are now limited to the 18.068- to 18.168-MHz range until you press **VFO/M** to return to memory channel operations, **VFO**►**M** to copy the displayed frequency to a memory, or **M**►**VFO** to write the displayed frequency to a VFO.

In this example, note that we overwrote the rear half of each memory with data we didn't need. For this reason, you may want to use the $P 1 \sim P 9$ memories only for subband-limited operation. In fact, if you want to make optimum use of this feature with the band-independent VFOs, you could keep all **VFO-A**s (that is, on each amateur band) set to the low edge of the subband you use, and all **VFO-B**s set to the high edge. By using the above procedure to load memories $P 1 \sim P 9$ when you change bands, and operating only in the memory tuning mode on the $P 1 \sim P 9$ memories, you can have the subband limits always enabled and never need the VFOs (except for storing the band limits).

Of course you don't have to use the VFOs to set up or store subband limits all the time, and for non-amateur-band subbands, such as the short-wave broadcast bands, you indeed cannot store the subband limits in the VFOs. Fortunately, since the **VFO**►**M** button lets you copy between memories when memory tuning is active, you can use any of the regular memories ($Q 1$ through $Q 9$) for storing any subband limits.

Digital Modes

In addition to SSB and CW operation, digital amateur modes such as RTTY, AMTOR, Packet and the new PacTOR and CLOVER data protocols offer an exciting variety of operating possibilities to explore. Use of these modes requires connecting your transceiver with a special modem commonly known as a TNC - "Terminal Node Controller" and a personal computer.

Terminal Unit/TNC Interconnections

While modem hardware configurations vary between TNC models and manufacturers, interfacing is basically the same. You need to provide receiver audio from your transceiver to the TNC, a PTT line to key the transmitter, and transmit audio line from the TNC to the transceiver. This requires constructing a special patch cable (check the documentation supplied with your TNC for its requirements).

The FT-840 provides the **PTT** phono jack on the rear panel for external transmitter activation (ground to transmit), and the **AF OUT** phono jack for constant line-level receiver audio (you can also use audio from the headphone or external speaker jack, but this is not recommended, since the audio level varies with the **VOL** control setting). Peak line-level audio at the **AF OUT** jack is about 100 mV at 600 Ω , so you may need to adjust the input level inside your TNC.

The FT-840 uses AFSK (Audio Frequency Shift Keying) tone input for RTTY, Packet and AMTOR operation. AFSK tones for transmission from your TNC must be injected via the front panel **MIC** jack. Therefore, a simple wiring scheme is to utilize pins 8 & 6 of the **MIC** jack for PTT control and transmit audio from the TNC, and use the rear-panel **AF OUT** jack for receive audio output to the TNC (see next page). In this case, the **PTT** phono jack on the rear panel is not used.

The schematic on the next page shows the transmitter audio input at the **MIC** jack. Input impedance at pin 8 is about 600 Ω , and peak input voltage should be 20 to 40 mV, so you may need to adjust the output level from your TNC to provide proper modulation level with the **MIC** gain control in the same position you use for voice operation. You still have to disconnect the microphone during data mode operation. To eliminate having to swap microphone and TNC plugs, you may want to construct a simple switch box to which you can connect both your TNC and microphone.

Transmitter Adjustment

Press the **AGC-F** button for fast AGC, and the **LSB** mode button for normal shift. The display shows suppressed carrier frequency, so bear in mind that your actual transmitted signal is offset below the display by the (audio) frequency of the AFSK tones generated by your TNC.

Before transmitting the first time, preset the **RF PWR** control to about 12 o'clock, and set the **METER** button to the **ALC** position. Key the transmitter from your keyboard, and adjust the **MIC** control (or TNC output level) for less than mid-scale indication.

Now you can set the **METER** button to the **PO** position, and set the **RF PWR** for the desired power output.

Frequency Display & Tuning

As mentioned above, the transceiver displays the suppressed carrier frequency, from which you must subtract the audio frequency of your TU's or TNC's AFSK tones to find the actual operating frequency. For example, if your TNC uses 1600- and 1800-Hz tones, you can subtract the difference (1700 Hz) from the display to find the actual center frequency of your transmitted signal. Also, you want to center your receiver audio passband at 1700 Hz, so you need to turn the **SHIFT** control counterclockwise to about the 11-o'clock position (the normal SSB passband is centered about 1500 Hz away from the carrier frequency).

Of course, if your TNC or TU uses higher-frequency tones, you have to shift the passband further.

Example: You want to have a packet QSO with a station who has told you they will be on 14.1013

MHz (sometimes called the old "14.103" according to the 1700-Hz TAPR convention), and your TNC uses 2115-/2315-Hz tones (like the MFJs). What frequency should your display show?

Unlike RTTY and AMTOR, which imply the mark frequency when setting up *skeds*, packet frequencies refer to the center of the two tones. With your modem, the carrier offset is in the middle between 2315 and 2115 Hz, or 2215 Hz. So if you're using LSB mode, you need to add this offset to the specified QSO frequency to get your displayed frequency: $14.10130 + 0.002215 \text{ (MHz)} = 14.103515$, which displays as either 14.103.51 or 14.103.52. On the other hand, if you're using USB mode, you subtract the offset, and your display shows 14.099.08 or 14.099.09.

Since tuning is very critical for F1 packet, you should enable display of the 10-Hz digit, by holding the **UP** button while switching the transceiver on. Tune the transmitter and receiver within 10 Hz of a signal to minimize repeats.

Caution!

Some digital modes (such as RTTY) require continuous key-down transmission. While the internal fan is designed to protect your radio from excessive heat, full key-down output for long periods is not recommended. Especially during hot or humid weather, we recommend reducing power to preserve the life of the components. During long transmissions, place your hand at the rear exhaust occasionally to ensure that it's not getting too hot. The safest approach is to keep power output at 50 watts or less during long transmissions.

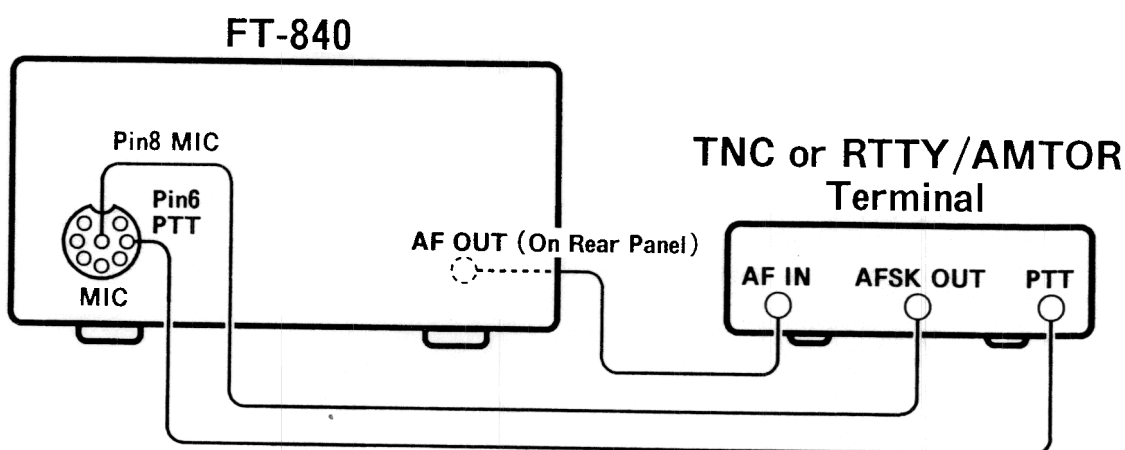

Packet TNC & RTTY/AMTOR Terminal Unit Interconnections

1200-Baud FM Packet

The equipment setup for 1200-baud FM packet (above 29 MHz) is the same as for 300-baud packet. There is no squelch output from the FT-840, however, so performance will be better on noisy channels if your TNC has PLL-type DCD. Tuning is much less critical in this mode, requiring no special adjustments.

To transmit FM packet, just press the **PO** meter selector button and adjust the **RF PWR** control for the desired power output.

AMTOR & F1 Packet Operation with the YF-112C 500-Hz Filter option

Obtaining optimum AMTOR, RTTY and 300-baud packet operation under QRM conditions may prove difficult, because the optional 500-Hz narrow CW filter is not available for reception in the SSB modes needed for AFSK transmission. You can keep operation simple (and avoid the need for the 500-Hz CW filter option) by using the LSB mode with its 2.4-kHz bandwidth for both transmission and reception, but the broad receiver IF bandwidth is not optimum for receiving narrow-shift AFSK under QRM conditions. Alternatively, if you have the 500-Hz CW filter installed, you can try using it for reception in CW mode and transmitting in an SSB mode (split); but this requires offsetting your transmit and receive frequencies, along with a few other inconveniences.

The following describes split-mode FSK operation, which you can try in order to obtain better performance from the FT-840 in this mode. *It will work with some TNCs/terminal units, but probably not all, depending on the AFSK tone frequencies used, therefore, neither Yaesu nor its representatives claims as to the suitability of the FT-840 for this application.*

As described earlier, if you choose to receive in the LSB mode (standard for HF narrow-shift AFSK), you need to turn the **SHIFT** control counter-clockwise according to your AFSK tone frequencies. If you use the USB mode instead, you need to turn it clockwise. Even so, the SSB IF filter pass-band (about 2.7 kHz) is much broader than 170-Hz shift RTTY, AMTOR and 200-Hz packet, and the extra noise will not give optimum performance under crowded QRM conditions. For 425- or 850-Hz wide-shift RTTY, however, the SSB filter is best.

After having some QSOs with the SSB filter as described previously, if you have the optional 500-Hz CW filter installed, you can try setting up split-mode operation. This involves setting up one VFO (or memory half) for receiving using the 500-Hz CW narrow filter. Unfortunately, if your TNC uses high AFSK tones (centered above 2 kHz), you may not be able to shift the IF quite enough. The initial setup is a little tricky, but the result can be nearly 5:1 improvement in signal-to-noise ratio on weak signals. The FT-840 has several features that keep the process from getting too complicated.

First you will want to disable the CW BFO offset from the display (as described on page 21) by holding the **BAND-DOWN** button while turning the transceiver on. Confirm that it is off by switching between CW and USB modes: the display should not change. In addition, activate the CW Reverse Sideband feature as described on page 21 (CW and LSB should sound and tune the same).

Store the offset of the center of your AFSK tones in the clarifier. This lets you keep the TX and RX VFOs (or memory halves) on the same frequency—which is important for tuning. To store the offset, tune to a 100 kHz multiple, like 14.100.0 MHz. Then add the center of your AFSK tones (for 170-Hz shift this is 2210 Hz for MFJ TNCs), to the displayed frequency (e.g., 14.100.0 + 0.002.21 =

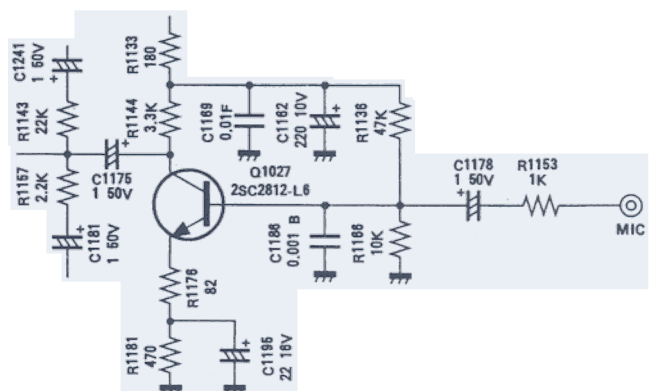
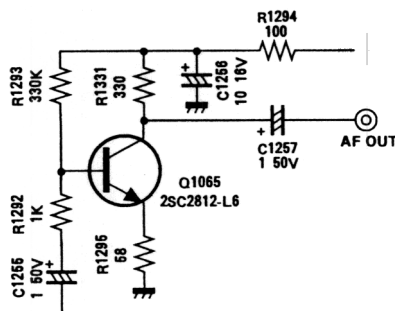

14.002.21). Then switch off the clarifier. Once it's set, be careful not to touch the **CLAR** knob! The setting must remain the same for all split-mode operation using these AFSK tones.

Now press the **CW/N** button, twice if necessary, so that "**NAR**" appears, and turn the **SHIFT** control counterclockwise from center. If your TNC has a tuning indicator, set the **SHIFT** so that the indicator is centered while receiving only background noise. Depending on the AFSK tone frequencies of your TNC, and on internal component tolerances in the FT-840, you may not be able to center the tuning indicator, even with the **SHIFT** control fully counterclockwise. If this appear to be the case, try it set fully counterclockwise anyway to see if reception is better than with the wide filter.

With the shift and clarifier set up, and the 500-Hz CW filter selected, you are ready to tune in a signal. Press **CLAR** to activate the clarifier before tuning (but don't touch the clarifier knob!). Start by tuning in a strong signal, and once your screen shows the signal being decoded, adjust the **SHIFT** control slightly for best copy.

The first time you transmit split-mode, we suggest you try responding to a CQ or calling a BBS, rather than initiating a CQ. First press the **SPLIT** button ("**SPLIT**" appears). With the station tuned for best copy, set up the alternate VFO (or memory half) to transmit in LSB with the appropriate frequency offset from your receiving (CW) frequency, like this: press **CLAR** to deactivate the clarifier, and **LSB** to change to the transmit mode. Then press **A=B** to copy the displayed frequency and mode to the hidden (TX) VFO or memory half. That sets up the transmitter. Finally, press **CLAR** and **CW/N** twice to return to the receive frequency/mode. Now you can transmit.

Again, the magic key sequence to set up the transmitter after tuning to a new frequency is: **CLAR - LSB - A=B - CLAR - CW/N - CW/N**. You need to do this every time you tune to a new frequency, so you might want to make a note of it.

Try to establish a connection with a moderately strong signal on a clear channel. If the connection is very poor (many repeats), move the **SHIFT** control very slightly to the right or left and see if the repeats decline. Continue in this manner until you find a "sweet spot" (with minimal repeats) for the **SHIFT** control, and make note of it. You will use this setting for all future LSB narrow-shift AFSK operation.

Final Note: Computer-Generated RFI

When using a TNC connected to your transceiver, or even having a PC located in the shack, the possibility exists that you may experience computer-generated RFI (Radio Frequency Interference).

The CPU in a personal computer operates with a crystal-controlled oscillator (clock) and timing circuits. Common clock frequencies include 8, 12, 16, 20 and 25 MHz. In addition, high-speed digital data switching uses square waves, which produce odd-order harmonic frequencies.

Computer-generated RFI may appear at seemingly random frequencies (usually right where a rare DX station is calling CQ!) throughout the range of your transceiver, and may sound like constant ticking or buzzing that may change as you type or work within a program. Severe RFI may have S-meter indications as strong as S-9 ~+10db over, making copy of voice signals difficult and data signals virtually impossible.

Computer-generated RFI is usually a result of inadequate shielding of the PC's cabinet or I/O and peripheral connections. While computer equipment may comply with RF emission approval standards, this does not ensure that sensitive amateur radio receivers will not experience RFI from the device.

There are a few steps you can take to reduce or eliminate computer-generated RFI. The first step is to ensure that only shielded cables are used for TNC-to-transceiver connections, carefully check RF ground connections and re-orient your station equipment in relation to the computer. Try moving your PC and peripherals slightly and see if it has any affect on the RFI, in some cases, this alone may be enough to correct the problem.

If not, several additional steps to try include installing AC line filters on the power cord(s) of the suspected equipment and inserting decoupling ferrite toroidal chokes on interconnecting patch/data cables and smaller ferrite beads on single wires.

As a last resort, you can try installing additional shielding within the PC case, using appropriate conductive mesh/screening or conductive tape. Especially check RF "holes" where plastic is used for cabinet front panels. For further information, consult amateur radio reference guides and publications relating to RFI suppression techniques.

Installing Internal Accessories

This chapter describes installation of the internal options available for the FT-840. The YF-112A and YF-112C crystal filters can be installed by removing only the top cover, while installing the TCXO-4 master oscillator requires first removing the bottom cover and then the top cover. This chapter describes the cover removal procedures first, followed by the individual procedures for each option. Proper performance with these options depends on proper installation. If you are unsure of the procedures after reading the following, feel free to ask your Yaesu dealer for help.

Top Cover Removal

- Turn the transceiver off, and disconnect all cables.
- Place the set on the work surface with the rear facing you, and remove the five screws affixing the top cover (Figure 1). Note the single rear screw is a different type than the rest (remember this when replacing the screws). Pry the top cover open and disconnect the speaker cable plug from its connector leading to the transceiver. Then lift the top cover off.

Filter & FM-Unit Installation

The 500-Hz YF-112C and 6.0-kHz YF-112A crystal filters may be installed for improved CW and AM receiver selectivity. The filter units have diodes installed which indicate their installation and enable selection from the front-panel. Installation of the FM Unit -747 permits narrow-band reception and transmission.

- Referring to the photo at the right, determine the correct location of the unit(s) you are installing. Filters and the FM-Unit are installed by plugging them into position as labeled on the circuit board and shown in the photo (Figure 2).
- If installing the TCXO-4, continue with the following steps; otherwise re-connect the speaker cable and replace the top cover.

TCXO-4 Enhanced-Stability Oscillator

The ± 2 -ppm TXCO-4 option can be installed as a replacement for the standard ± 10 -ppm crystal oscillator.

- Remove the top cover as described above.
- Now flip the transceiver on its top side and remove the six screws affixing the bottom cover.

Figure 1: Top Cover Removal

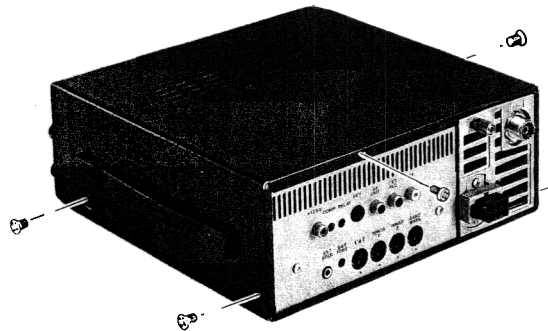

Figure 2: Filter & FM Unit Location

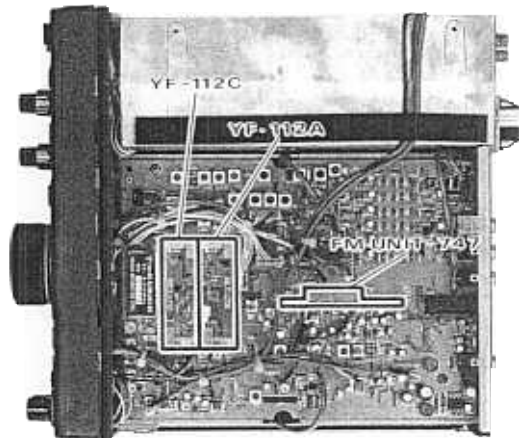
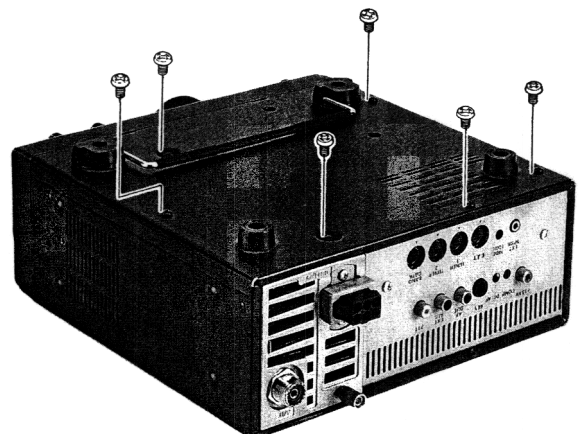

Figure 3: Bottom Cover Removal



Installing Internal Accessories

Fig. 4: TCXO-4 Installation

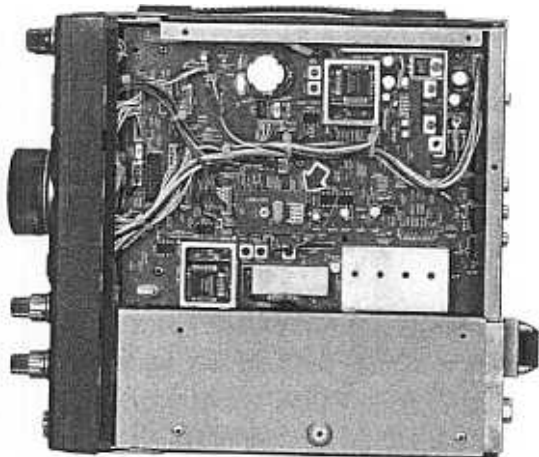

Fig. 5 Lithium Battery

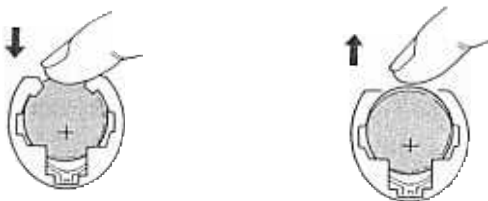
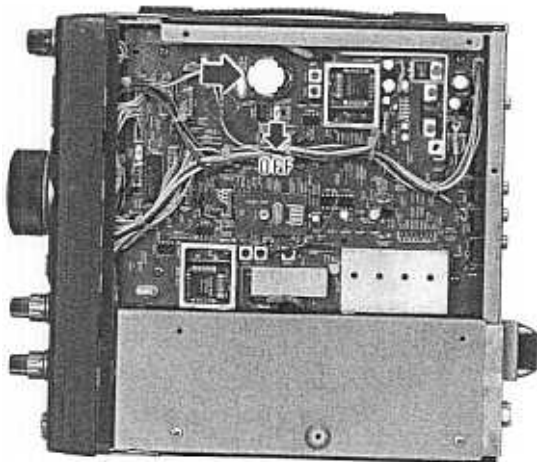

Fig. 6 Backup Switch



- Referring to Figure 4, locate the standard OSC UNIT at approximately the center of the board. Squeeze the tip of the nylon stand-off with a pair of pointed pliers, and pry up that side of the OSC UNIT slightly. With your thumb and two fingers, gently pry up the opposite side of the board, then lift the entire unit from the board.
- The TCXO-4 is installed in the same manner. Align the 4 pins extending from the board with the connector on the unit, then press it firmly in place (until the tip of the nylon stand-off protrudes through the mounting hole).
- Replace the bottom cover (six screws), turn the set over and then replace the top cover (ball towards the front) and its five screws.

Lithium Battery Replacement & Memory Back-Up Switch

A 3-volt Lithium Battery (P/N BT2001) is located on the bottom circuit board of the transceiver (see Fig. 6). This maintains the memorized data in your radio. Normal battery life is usually greater than five years, however, should replacement be needed, perform the following steps.

- With the top and bottom covers removed, note the location of the battery. Using your finger, slide the battery inward (you will feel slight pressure by the mounting spring), then slightly pry it up and outward so that it ejects freely through the slots in the battery holder (Fig. 5).
- Carefully note battery polarity with the positive (+) side facing upward, and battery-type information. Install the replacement battery in the reverse manner.

Back-Up Switch

Located next to the lithium battery is the memory **BACK UP** switch (Fig. 6). This is normally kept in the ON position to ensure your memorized data is maintained (by a small amount of power from the lithium battery) when the radio is off, or the DC power source is removed.

- If you do not plan to operate your radio for extended periods of time, slide this switch to the OFF position to conserve battery life.
- Ensure the radio is powered on when sliding the switch back to the ON position, as this reduces the initial current demand on the battery by the radio's circuits from an un-powered state.

Note: memorized settings will be lost and the radio will return to factory default settings when turning off the backup battery. This has the same effect as performing the power-on sequence described on page 13.

CAT System Computer Control

The CAT (Computer Aided Transceiver) System in the FT-840 provides control of frequency, mode, VFO, memory and other settings by the operator's external personal computer. This allows multiple control operations to be fully automated as single mouse click or keystroke operations on the computer keyboard.

Serial data is passed at TTL levels (0 and +5V) via SO (serial output) and SI (serial input) pins 2 and 3 of the CAT jack on the rear panel of the transceiver, at 4800 bits/s. CAT jack pinout is shown on page 10. Each byte sent consists of one start bit, 8 data bits, no parity and two stop bits:

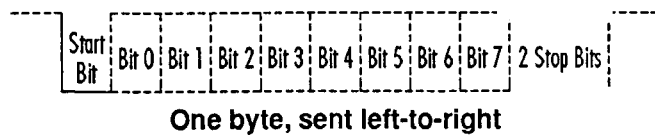

All commands sent to the transceiver must consist of *blocks* of five bytes each, with up to 200 ms between each byte. The last byte sent in each block is the *instruction opcode*, while the first four bytes of each block are arguments: either parameters for that instruction, or dummy values (to pad the block out to five bytes):

4th Arg Byte	3rd Arg Byte	2nd Arg Byte	1st Arg Byte	Opcode
--------------	--------------	--------------	--------------	--------

5-Byte Command Block, send left-to-right

There are twenty-four instruction opcodes for the FT-840, listed in the table on the next page. Notice that several instructions require no specific parameters, but every command block sent to the transceiver *must* consist of five bytes.

The CAT control program in the computer must construct the 5-byte block by selecting the appropriate instruction opcode, organizing the parameters, if any, and providing unused (dummy) argument bytes for padding (dummy bytes may have any value). The resulting five bytes are then sent, *opcode last*, to the SI serial input pin of the CAT jack on the transceiver.

Example: Tune to 14.25000 MHz;

- First determine the opcode for the desired instruction (see the CAT Commands table, next page). These opcodes should be stored in the program so they can be looked up when the user requests the corresponding command. In this case the instruction is "Set Op Freq", so the opcode is 0Ah. Small "h" following each byte value indicate hexadecimal (base 16) values.
- Build the four argument byte values from the desired frequency by breaking it into 2-digit blocks (BCD "packed decimal" format). Note

that a leading zero is always required in the hundred's-of-MHz place (and another in the ten's-of-MHz if below 10 MHz).

- The resulting 5-byte block should look like this (again, in hexadecimal format):

Byte Value		01h	42h	50h	00h
Content of this byte	Set Op Freq. opcode	100's & 10's of MHz	1's of MHz & 100's of kHz	10's & 1's of kHz	100's & 10's of Hz

- Send these five bytes to the transceiver, in *reverse order* from that shown above — from right-to-left (see the examples on page 38).

Data Returned From FT-840

The *Status Update*, *Read Flags* and *Read Meter* commands cause the FT-840 to report various operational and internally stored settings on the SO (serial output) line:

Status Update causes the FT-840 to return all or portions of its RAM table (up to 1941 bytes).

Read Flags obtains only the first 3 bytes (the Status Flags) from the RAM table, plus 2 extra "filler" bytes (08h and 41h),

Read Meter returns the meter deflection (0 — 0FFh) repeated in four bytes, followed by one "filler" byte (0F7h).

Each returned byte may be delayed by an interval determined by the *Pacing* command (0 to 255 ms in 1-ms steps). This delay is initially zero until the *Pacing* command is sent. This allows returned data to be read and processed by even very slow computers. However, you should set it as short as your computer will allow, to minimize the inconvenience of the delay. In the worst case, when the radio is to return all 1941 bytes of internal data, about 1.4 seconds is required with "0"-length delay selected, but almost 3 *minutes* if the maximum delay is selected!

Status Update Data Organization

The 1941 bytes of *Update* data is organized as shown at the top of the page after next. Aside from the *Read Flags* command, different portions of this data can be returned in blocks of 1, 18, 19 or 1941 bytes, depending on the parameters of the *Update* command sent by the computer. The details of these commands follow the descriptions of the data.

English

CAT System Computer Control

CAT Commands

Legend:

Send all commands in REVERSE order from that shown! Commands that duplicate a front panel button are named with all caps. Parameter variables are named to reflect their format: eg., "CH" indicates a memory number, from 1 to 64h (1 to 100 decimal).

"—" indicates a padding byte. Value is unimportant, but it must be present to pad the block out to exactly five bytes.

Opcodes are listed in both hex and decimal format for convenience - only one opcode byte can be actually sent.

English

Command	Opcode		Parameter Bytes				Parameter Description
	hex	(dec)	1	2	3	4	
SPLIT	01	1	T	-	-	-	Switch Split tx/rx operation ON (T=1) and OFF(T=0)
Recall Memory	02	2	CH	-	-	-	Recalls memory number CH: 1 to 64h corresponding to memories 1 through P0
VFO \rightarrow M	03	3	CH	P2	-	-	Code display to memory CH (P2=0), Hide CH (P2=1) or Unhide CH (P2=2)
LOCK	04	4	P	-	-	-	Tuning knob or panel lock/unlock(P=1/ 0)
A/B	05	5	V	-	-	-	Select operation on VFO A (V=0) or VFO B (V=1)
M \rightarrow VFO	06	6	CH	-	-	-	Copy memory CH (1 to 64h) to last-used VFO
UP	07	7	00h	S	-	-	Step current display up 100 kHz (S=0) or 1 MHz (S=1)
DOWN	08	8	00h	S	-	-	same as UP, but steps down
CLAR	09	9	C	-	-	-	Clarifier on/off (C=1/ 0)
Set Op Freq.	0Ah	10	F1	F2	F3	F4	New operating frequency in F1 - F4, in BCD format: see text for example
MODE	0Ch	12	M	-	-	-	M values: LSB=0, USB=1, CW-wide=2, CW-nar=3, AM-wide=4, AM-nar=5, FM= 6 or 7
HAM/GEN	0Dh	13	HG	-	-	-	Select HAM/GEN stepping functions (H/G=0/1)
Pacing	0Eh	14	N	-	-	-	Add N-millisecs (0-OFFh) delay between bytes of all data returned from radio
PTT	0Fh	15	T	-	-	-	Transmitter on (T=1) or off (T=0)
Status Update	10h	16	U	-	-	CH	Instructs the radio to return 1, 18, 19 or 1941 bytes of Status Update data. CH is significant only when U1=4. See text
TUNER	81h	129	T	-	-	-	Switch antenna tuner on (T=1) or off (T=0)
START	82h	130	-	-	-	-	Start antenna tuner
RPT/T	84h	132	R	-	-	-	Select simplex (R=0), -shift (R=1), or +shift (R=2)
A=B	85h	133	-	-	-	-	Copy displayed VFO(A or B) data to other VFO (B or A, resp.)
Memory Scan Skip	8Dh	141	CH	T	-	-	For memory CH (1 - 64h), skip (T=1) or include (T=0) in scanning
Step Op Freq.	8Eh	142	D	-	-	-	Step operating freq up (D=0) or down (D=1) minimal step (10- or 100- Hz)
Read Meter	0F7h	247	-	-	-	-	Instructs radio to return digitized meter indication (4 repeated bytes, and 0F7h)
Rptr Offset	0F9h	249	00h	S2	S3	S4	Set offset for RPT shifts, valid values are 0 - 500,000Hz (BCD format, in S2 - S4). Parameter 1 must be zero, S2 must be 0, 1 or 2. S3 is 1's & 10's of kHz, S4 is 10's & 100's of Hz.
Read flags	0FAh	250	-	-	-	-	Instructs radio to return the 24 1-bit Stats Flags (5 bytes, see following pages)

All 1941 Bytes of Status Update Data (Sent L-to-R)

Flags	M	Operating Data Record	VFO-A Data	VFO-B Data
3	1	19 bytes	9 bytes	9 bytes
(A)	(B)	(C)	(D)	(E)

(A) Flag Bytes

The first 3 bytes are treated as 24 1-bit flag fields: a function is enabled (on) if a bit is set (1), and disabled (off) if reset (0). Most of the functions represented by these flags correspond to the radio display.

First Flag Byte

- Bit 0: LOCK is active (= display)
- Bit 1: GEN operation (= display)
- Bit 2: SPLIT operation (= display)
- Bit 3: Memory checking (M CK) in progress
- Bit 4: Memory tuning (M TUNE) activated
- Bit 5: MEM operation (= display)
- Bit 6: VFO B in use for transmit or receive
- Bit 7: VFO A or B operation (= display)

Second Flag Byte

- Bit 0: PTT line closed by CAT command
- Bit 1: Memory scanning is paused
- Bit 2: Scanning in progress (paused or not)
- Bit 3: Not used
- Bit 4: Not used
- Bit 5: Antenna Tuner tuning (WAIT)
- Bit 6: High SWR (= display)
- Bit 7: FAST tuning/scanning rate is activated

(B) Fourth Byte: Memory Number

The 4th byte of Update data contains a binary value between 0 and 63h (99 decimal), indicating the current memory number -1 (or the last-selected memory, if operating on a VFO). note: P1=54h, p0=63h.

(C) 19-Byte Data Records

The Memory Number is followed by a 19-byte record defining current operating conditions. That is, the two VFOs if operation is on a VFO, or the front and rear halves of the current memory if

19-Byte Data Record Format

1 byte	9 bytes	9 bytes
Mem-Flag	VFO-A or Memory Front	VFO-B or Memory Rear

Memory Status Flags (1 Byte)

This byte is at the head of every 19-byte Data Record. Bits 0 through 5 are not used. Bit 6 is set if the SPLIT function is active on the memory, and Bit 7 is set if the memory is blanked.

VFO/Memory Data Record (9 Bytes)

The structure of a 9-byte VFO/Memory Data record is detailed in the table below. Each byte in the table is identified by its offset from the start (base address) of the record, since the same 9-byte record format is also used elsewhere.

9-Byte VFO/Memory Data Record Format

Offset	Contents & Format of Byte Field
0	BPF selection: 0 to 09h binary
1-3	Bytes 1 — 3: Base frequency in 10's of Hz (w/o clar/rpt offset). Binary value in range 10000 — 3000000. Byte 1 is MSB.
4-5	not used
6	Mode: 0=LSB, 1=USB, 2=CW, 3=AM, 4=FM
7	not used
8	VFO/Memory Operating Flags (see below)

VFO/Memory Operating Flags

Each bit in this field signifies a state unique to one VFO or half-memory.

- Bit 0: frequency not 100 Hz multiple (AM or FM operation)
- Bit 1: SSB mode (0: LSB, 1:USB)
- Bit 2: Memory set to SKIP when scanning
- Bit 3: - Repeater Shift (for FM only)
- Bit 4: + Repeater Shift (for FM only)
- Bit 5: not used

- Bit 6: Current mode is AM NARrow
- Bit 7: Current mode is CW NARrow

(D) & (E) VFO-A and VFO-B Data (9 bytes x 2)

After the 19-byte Data Record for current operation is sent, two 9-byte VFO/Memory Data Records are sent; one for each VFO. The format of each of these records is the same as described above, and in fact, when operating on a VFO, the values in these records are identical to the two 9-byte records included in the 19-byte Data Record for current operation.

(F) Memory Data Records

After the two 9-byte records for the VFOs, 100 19-byte Data Records are sent: one for each memory, beginning with memory 01. Each memory data record is constructed as described above for the 19-byte Data Records.

Status Update Data Selection

The 1st and 4th parameters of the Status Update command allow selection of different portions of the Status Data to be returned, as follows ("U" is the 1st parameter, "CH" is the 4th):

Parameters	Data Returned	Reference (see previous page)
U=0	All 1941 bytes	A
U=1	Memory Number	B
U=2	19-Byte Operating Data Record	C
U=3	18-Byte VFO-A & VFO-B Data	D & E
U=4, CH=1 ~ 64h	19-Byte Mem Data Record for mem CH	F

Note that, in most cases, you will only need to read the 19-byte Operating Data Record (with the first parameter = 2), since *all other CAT commands affect only this data* (except **VFO > M** and **Memory Scan Skip**).

Read Flags Data

The *Read Flags* command retrieves the (first) 3 Flag Bytes of the Status Data. The transceiver responds to the *Read Flags* command by returning the Flag Bytes described on the preceding page, plus two bytes with the constant values of 08h and 41h (in that order), as shown here:

1st Flag Byte	2nd Flag Byte	3rd Flag Byte	Dummy (08h)	Dummy (41h)
---------------	---------------	---------------	-------------	-------------

Read Meter Data

Sending the *Read Meter* command causes the transceiver to return a digitized meter deflection indication, between 0 and 0FFh (in practice, the highest value returned will be around 0F0h). Four copies of this value are returned, along with one constant byte (0F7h), as follows:

Meter Byte	Meter Byte	Meter Byte	Meter Byte	0F7h
------------	------------	------------	------------	------

During reception, the signal strength deflection is returned. During transmission, the power output level deflection is returned.

Coding Examples

Although Yaesu Musen Company cannot offer to provide complete CAT control programs (owing to the variety of incompatible computers used by our customers), following are a few examples of critical CAT i/o functions, in BASIC. Note that all variations of BASIC may not support some of the commands, in which case alternate algorithms may need to be developed to duplicate the functions of those shown.

Sending a Command

After "opening" the computer's serial port for 4800-baud, 8 data bits and 2 stop bits with no parity, as i/o device #2, any CAT command may be sent. However, if you determine that your computer may need extra time to process data returned from the transceiver, you should send the *Pacing* command first. Here is an example of the *Pacing* command setting a 2-ms delay:

```
PRINT #2, CHR$(0);CHR$(0);CHR$(0);CHR$(2);CHR$(&HE);
```

Notice that the instruction opcode is sent last, with the first (MSB) parameter sent just before it, and the LSB parameter (or dummies) sent first. The parameters are sent in the reverse order from that in which they appear in the CAT Commands table. Also note that in this and the following examples, we are sending zeros as dummy bytes; although this is not necessary. If you decide to send commands through a 5-byte array, the values of the dummy parameters need not be cleared.

Using the same example as on page 31, the following command could be used to set the frequency of the display to 14.25000 MHz:

```
PRINT #2, CHR$(&H00); CHR$(&H50); CHR$(&H42); CHR$(&H01); CHR$(&HA);
```

Notice here that the BCD values can be sent just by preceding the decimal digits with "&H" in this example. However, in an actual program you may prefer to convert the decimal frequency variable in

English

prefer to convert the decimal frequency variable in the program to an ASCII string, and then to convert the string to characters through a lookup table.

If you send a parameter that is out of range for the intended function, or not among the specified legal values for that function, the FT-840 should do nothing. Therefore, you may wish to alternate your sending regular commands or command groups with a *Read Flags* or an *Update* command, allowing the transceiver to let the computer know if everything sent so far has been accepted and acted upon as expected.

Bear in mind that some commands specify "binary," as opposed to BCD-formatted parameters. You can send binary parameters without going through the character/hex string conversion process. For example, the CH parameter in the Command table is binary. You could have the FT-840 recall memory 29 (decimal) by the following:

```
PRINT #2, CHR$(0);CHR$(0);CHR$(0);CHR$(29);CHR$(2);
```

Reading Returned Data

The reading process is easily done through a loop, storing incoming data into an array, which can then be processed after all expected bytes have been read into the array. To read the meter:

```
FOR I=1 TO 5  
  MDATA(I) = ASC(INPUT$(1,#2))  
NEXT I
```

Recall from above that the meter data consists of four identical bytes, followed by a filler byte, so we really only need to see one byte to get all of the information this command offers. Nevertheless, we must read all five bytes (or 1, 18, 19 or 1941, in the case of the Update data). After reading all of the data, we can select the bytes of interest to us from the array (MDATA, in the above example).

YAESU

...leading the way.SM

YAESU MUSEN CO., LTD.

4-8-8 Nakameguro, Meguro-Ku, Tokyo 153-8644, Japan

YAESU U.S.A.

17210 Edwards Rd., Cerritos, CA 90703, U.S.A.

YAESU EUROPE B.V.

P.O. Box 75525 1118 ZN, Schiphol, The Netherlands

YAESU UK LTD.

Unit 12, Sun Valley Business Park, Winnall Close
Winchester, Hampshire, SO23 0LB, U.K.

YAESU GERMANY GmbH

Am Kronberger Hang 2, D-65824 Schwalbach, Germany

YAESU HK LTD.

11th Floor Tsim Sha Tsui Centre, 66 Mody Rd.,
Tsim Sha Tsui East, Kowloon, Hong Kong

