

New Product Release Information

TS-990SE

HF/50MHz All-Mode Transceiver

January 2013

We are pleased to inform you of our new HF/ 50MHz all mode Transceiver for Amateur Radio.



1. SCHEDULE

Launch:

End of February 2013

2. MAIN FEATURES

2-1. Main receiver

Down conversion format for all amateur bands

A key point in tapping maximum performance from the 1st mixer in actual operation (say, CW operation) is to prevent the outflow of unnecessary signals, other than the target signal, from the mixer to the subsequent stage. This is because it can tap the maximum performance of the digital IF filter using the DSP in the final IF stage. The TS-990 main reception unit employs a 1st IF frequency 8.248 MHz down-conversion format. It achieves superior close-in dynamic range unattainable through conventional up-conversion formats. Even if the interference is a close-in frequency, the receiver maintains a relatively flat dynamic range, which you can tune without losing your target signal.

Newly developed mixer

In place of the Double Balanced Mixer, which uses the conventional J-FET, we have installed the newly developed Double Balanced Grounded Switch Type in the 1st mixer circuit, which is the heart of the main receiver. The transceiver is also equipped with a pre-selector function that varies the tuning frequency in tandem with the reception frequency. It effectively dampens strong interference signals that cannot be minimized through bandpass filters on dedicated amateur bands. Furthermore, we have achieved a +40dBm class of third-order intercept points for the signal path of the 1st mixer, based on selected circuits and components, and by employing large-sized core toroidal coils for protecting against distortion based on large input signals, as well as using relays for the signal switching.

Newly developed narrow-band High-IP roofing filter

The transceiver uses a down-conversion method for all amateur band reception, and features five types of High-IP roofing filter. Narrow bandpass widths selectable are 500 Hz and 270 Hz for CW operation, 2.7kHz for SSB and 6kHz and 15kHz, which are suitable for AM/FM. These filters are automatically selected in tandem with DSP-based final bandpass settings. Of course, manual switching is possible as well.

Newly developed VCO frequency division 1st local oscillator

The TS-990 Local Oscillator Circuit is an independent configuration that combines the main receiver and VCO Frequency Division/DDS Direct, the sub-receiver and DDS Direct, and the transmission unit and conventional PLL, with the targeted signal system. The newly developed VCO frequency division format is used for the 1st local oscillator of the main receiver. The device achieves favourable C/N characteristics that rival the DDS direct format, and relatively spurious-free local oscillation signals that are characteristic of the PLL format, by oscillating and dividing the VCO at higher frequencies than the intended frequency. It is possible to convert it to 1st IF in a pure state without leaking the target signal as noise by reducing static noise from the local oscillator and increasing the C/N ratio.

Equipped with ± 0.1 ppm TCXO

The standard equipment includes a TCXO (temperature-compensated crystal oscillator), which stabilizes frequencies at ± 0.1 ppm as the standard signal source. Unlike OCXO (Oven Controlled crystal Oscillator), which requires warm-up time, this device can start up quickly even from the power-off position, while maintaining a high level of stability. It is in compliance with European energy-saving standard Lot6. Power consumption in stand-by energy-saving mode is less than 0.5 W. A BNC connector on the rear panel provides 10MHz reference I/O.

2-2. Sub receiver

Down conversion for amateur bands below 15m

The sub-receiver features reception performance that has exceeded its class since going on sale, thus further refining this popular receiver on the TS-590. Because this is particularly the case on the front end, where it employs circuit configuration that makes down-conversion possible on the leading five amateur bands, it can be used in actual operation despite being just a sub-receiver.

** The IF bandwidth for 160m/80m/40m/20m/15m bands is (SSB/CW/FSK/PSK) for frequency levels 2.7 kHz or below.*

Roofing filter, 500 Hz, 2.7 kHz

Frequencies of 500 Hz and 2.7 kHz are standard for sub-receiver roofing filters. You can maintain a more or less flat dynamic range even if interference impinges on your reception frequency, thanks to superior close-in dynamic range properties. You can clearly catch signals under conditions made problematic by strong close-in interference signals.

2-3. Triple DSP

Equipped with dedicated DSP for the main-receiver, sub-receiver and band scope

Kenwood continues to provide quality sound transmission that is unattainable through analogue circuits. By loading the world-premiere DSP on the TS-950 and achieving IF AGC control on the TS-870 by using DSP for the first time for amateur wireless devices. As a culmination of the foregoing developments, three DSP units are used, one on each major block of the TS-990. By distributing the signal processing of the main IF, band scope, and sub-IF, we have realized ample digital signal processing. (FM mode is AF DSP processing.)



Advanced AGC control

The reception sound quality of SSB and CW is not solely determined by audio frequency and filter delay properties. AGC characteristics play a very significant role as

well. The opinion of many of our fans that “even for long periods of time they never get tired of listening” is due to the characteristics of Kenwood’s AGC. The TS-990 goes a long way in helping further refine the Kenwood tone by innovating not only the AGC control algorithm on the DSP but also the analogue AGC unit as well.

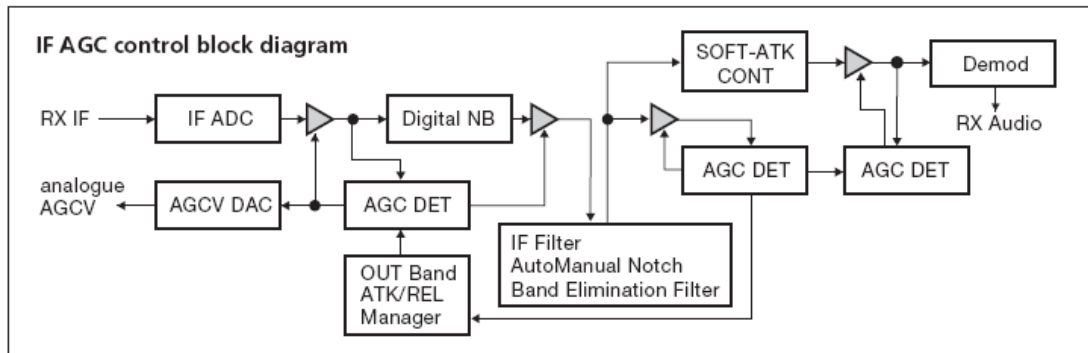

Exacting chassis design

The sound quality of the built-in speakers is largely determined by the chassis structure. With the TS-990, we have been able to minimize unnecessary chassis vibration through multiple simulations from the conceptual phase. The Kenwood tone is supported not only by circuits and DSP but also by exact chassis design.

Extensive interference elimination and noise reduction functions

- IF filter bandwidth variability
- IF filter A/B/C one-touch switch instantly
- IF notch
- Band elimination filter function
- The noise blanker function (NB1/NB2)
- DSP-based noise reduction function (NR1/NR2)
- Beat cancel function (BC1/BC2)
- Audio peak filter

2-4. Transmitter

High reliability design

The device uses POWER MOSFET VRF150MP, which runs at 50V, with push-pull. You can obtain a high, stable output of 200 W on all bands. You can achieve superior IMD properties by pursuing bias and matching conditions in order to fully exploit the 30FET attributes. Further, you can realize Kenwood’s distinctive tone by amplifying the clean modulated signal produced by DSP with an amplifier that exhibits excellent linearity.



Built-in automatic antenna tuner

The built-in automatic antenna tuner is a preset type that covers amateur band frequencies ranging from 160m~6m, and can be switched in on receive too. The tuner is capable of rapid QSY based on instantaneous band change, using a relay system known for high-speed operations. The relays, capacitors, and inductors use large-sized components that are able to bear the 200 W output.

Cooling system

Cooling is very important to obtain a stable output of 200 W. Heat dissipation efficiency is increased in the TS-990 through a large fin-type aluminium heat sink. An independent variable-speed fan is provided for the switching power supply, final unit, and antenna tuner, cooling each unit with a sufficient air supply. The switching power supply and the final unit have twin cooling fans. Noise is reduced by controlling the fan speed according to the temperature.

2-5. Dual display



Main display

The main display shows basic information about the frequency, mode, meter, and others functions, as well as the on/off status of the other accessory functions. You can also view internal parameter settings and memory lists. In addition, it features a band Viewscope function that allows you to monitor band status. Execute fast sweeps with FFT processing using DSP. Switch to different view modes such as waterfall and reception/transmission equalizer views.



Touch-Sensitive mode

Simply touch the main screen for quick QSY re-tuning.

Sub band display

The 3.5" TFT sub band display is located above the main dial, which not only reduces eye movement in reading the frequency, but also allows you to monitor the target signal itself by displaying the demodulated audio spectrum. In addition, filter effects can be displayed on the easy-to-see sub band display, allowing for intuitive operation. You can switch the sub band display between the four different view modes below according to your intention.



Single Frequency Display With Virtual Dial

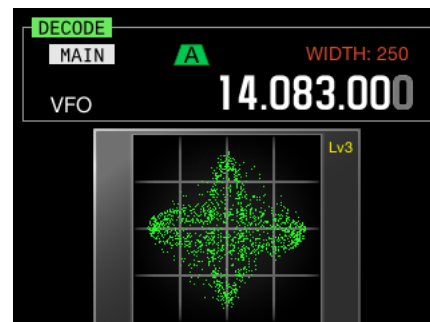

FSK mode

2-6. Control

New frequency function

You can use the frequency function that switches legacy VFO A/VFO B by switching the main and sub band. Turn the sub band reception on and off using the RX key on top of the main dial, and switch between simplex and split using the TX key. A single glance at the LED lighting lets you know the current status.

New split function

Just as with the legacy series, you can add functions via M>S and M/S giving a dual-action quick-split set up.

Memory channel

Memory for a maximum of 120 channels is available. In addition to the repeater frequency, you can also preset beacons and transmission stations. You can easily call up the states of simultaneous dual reception using the dual channel memory.

USB port

The front panel is equipped with two USB ports (A/B) for keyboard or USB flash drive. Switch to update mode and insert USB memory into the USB-A port on the front panel, and the update will automatically begin. In addition, access your USB memory from your PC by connecting your PC via USB cable to the USB-B port on the rear panel, switch to update mode, and a folder named TS-990 will appear on your computer.

External I/O interface

There are a variety of I/O interfaces, including the microphone jack, analogue audio input and output, USB audio interface, and optical digital interface. By combining DATA

mode (1-3) with SSB/FM/AM modes, it is possible to easily switch between an external device for modulation and demodulation. Switch between DATA VOX function and mute for each modulated line.

DSP equalizers

In addition to the legacy presets, up to a maximum of three user settings can be configured. You can store the equalizer settings used for each mode and enjoy a very comfortable rag-chew session with others.



Remote PC operation

Using the ARCP-990 software (radio control software), you can control most functions from your PC. Control the memory channel, settings, and functions using your PC. Using the ARHP-990 software (radio host software), the local PC can relay control data between the local TS-990S and the remote (operator) PC. Download the free software from the Kenwood website.

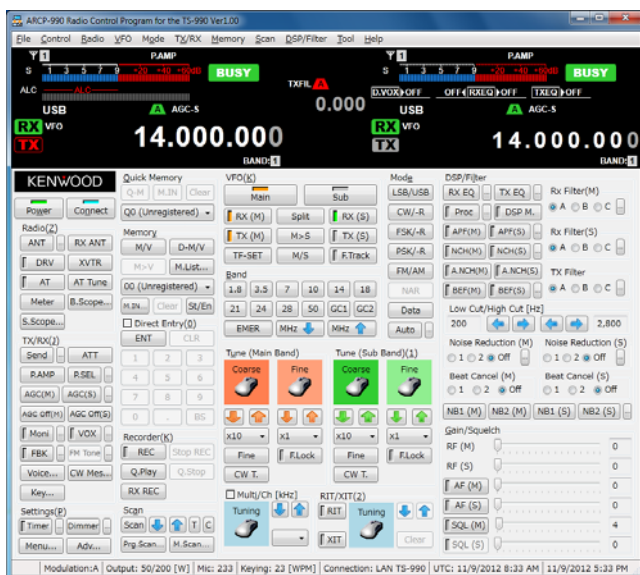

ARCP-990

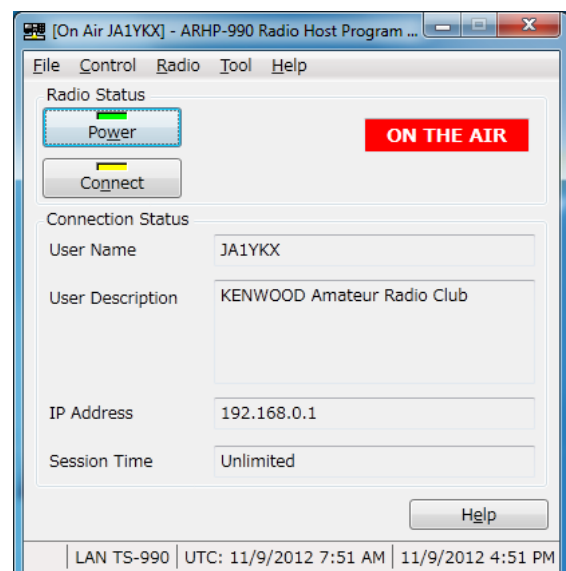

ARHP-990

Front/Rear Panel

Rear Panel

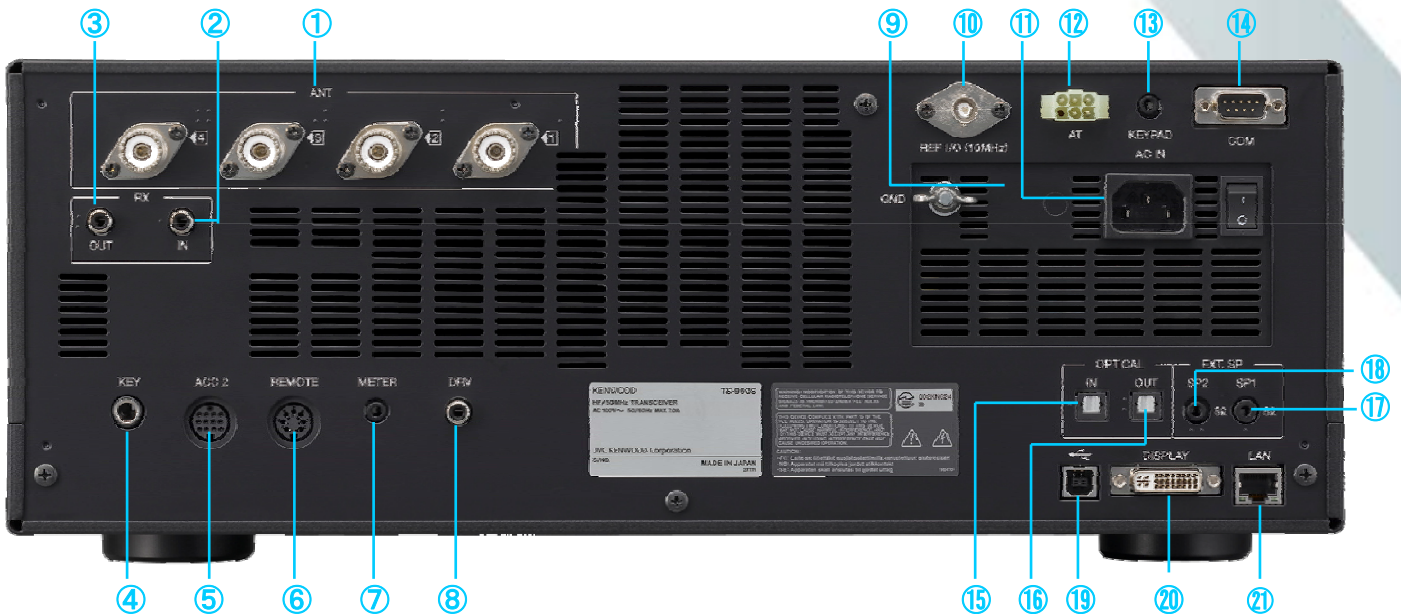

- ① Antenna Connector x 4
- ② RX IN Connector (RCA): Receive Only Antenna Terminal
- ③ RX OUT Connector (RCA): External Receiver Connection Terminal
- ④ Key Jack (φ 6.3): For Paddle, Vertical Bug Key, and PC Keying
- ⑤ ACC2 Connector (13Pin DIN): Audio I/O and Other Accessories Connection
- ⑥ Remote Connector (7 Pin DIN): Linear Amplifier Connection
- ⑦ Meter Jack (φ 3.5): Analog Meter Connection
- ⑧ Drive Connector (RCA): Drive Output
- ⑨ Ground Terminal
- ⑩ Standard External I/O Terminal (BNC): 10MHz
- ⑪ AC Power Supply Connector (3 Pin)
- ⑫ AT Connector (6Pin): External Antenna Tuner Connection
- ⑬ Keypad Jack (φ3.5): Function Key Pad Connection
- ⑭ COM Connector (D-SUB 9Pin): RS-232C
- ⑮ Optical Connector Input Terminal (EIAJ Optical)
- ⑯ Optical Connector Output Terminal (EIAJ Optical)
- ⑰ External Speaker Jack 1 (φ3.5)
- ⑱ External Speaker Jack 2 (φ3.5)
- ⑲ USB Connector (USB-B): PC Control, USB Audio
- ⑳ Display Connector (DVI-I): External Display Connection Terminal
- ㉑ LAN Connector (RJ-45): PC Control

FRONT Panel

- ① Headphone Jack (φ6.3)
- ② Paddle Keyer (φ6.3)
- ③ USB Connector (USB-B): PC Control, USB Audio
- ④ Microphone Jack (8 Pin Metal Type)



Dimensions

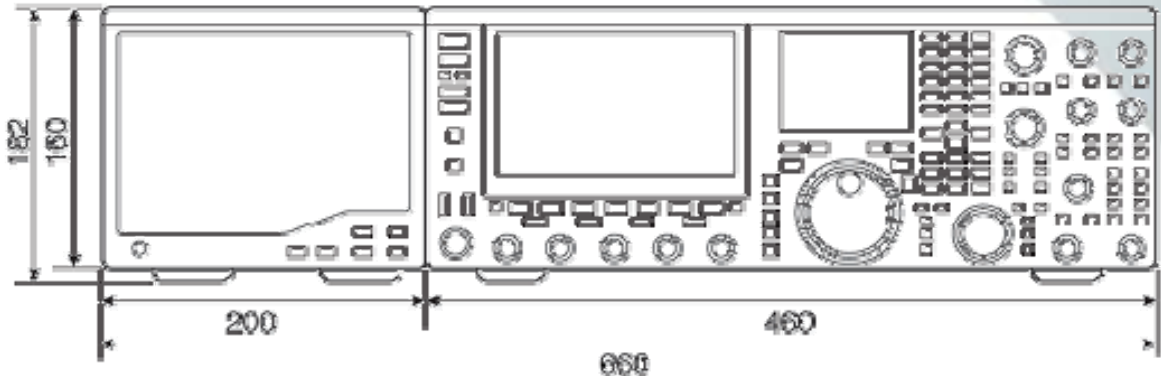

TS-990
Height when front legs are folded
H201(front) H172(back)



SP-990
Height when front legs are folded
H201(front) H180(back)

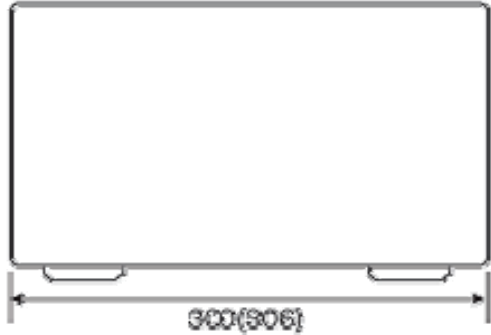

Size within the parenthesis () includes protruding objects. Unit: mm

3. QUALITY CONTROL

ISO 9001 Quality Management for Manufacturing

The TS-590S is manufactured in Kenwood's Japan factory which has been assessed and registered as ISO9001 compliant. ISO9001 is the international standard for Quality Management Systems.

4. OPTIONAL ACCESSORIES

- HS-5*1 Headphone (Open Air)
 - HS-6*1 Headphone (Light Weight)
- *1 The users can listen each reception sound of main/sub-band separately by using a stereo Headphone on the TS-990S. HS-5 and HS-6 are monaural. We recommend to use stereo headphone to fully utilize simultaneous dual reception function of the TS-990St.*
- MC-43S Hand Microphone
 - MC-47 Hand Microphone
 - MC-60A Desktop Microphone
 - MC-90 Desktop Microphone (DSP Compatible)
 - SP-23 External Speaker
 - SP-50B Mobile Speaker
 - SP-990 (NEW) External speaker
 - ✓ The SP-990 is designed to have the Kenwood-tone and the best matching with consideration for the built in speaker of the TS-990S.
 - ✓ Thanks to equip High/Low cut filter independently, the SP-990 can be setting to an appropriate sound character as the situation demands.
 - ✓ Full-range speaker (5W, 8Ω)
 - ✓ Built-in filters (3 x high-cut, 3 x low-cut)
 - ✓ 2 inputs (A/B)
 - ✓ Mute



- ARCP-990*2,3 (NEW) Radio Control Program for Windows OS*4
- ARHP-990*2,3 (NEW) Radio Host Program for Windows OS*4
- ARUA-10 ver2.00*2,3 USB Audio Controller Program for Windows OS*4

*2 These are going to be a free download from

www.kenwood.com/i/products/info/amateur/software_download.html

*3 To connect your TS-990S to a PC via its USB port, install the Silicon Laboratories Inc. virtual COM port driver in the PC first. It is going to be a free download from

www.kenwood.com/i/products/info/amateur/vcp_e.html

*4 Windows® is a registered trademark of Microsoft Corporation in the United States and other countries. ARCP/ARHP-990 and ARUA-10 are compatible with Windows XP (32-bit, SP3 or later), Windows Vista (32-bit, SP2 or later), and Windows 7 (32-bit/64-bit) operating systems

5. SUPPLIED ACCESSORIES

- AC Power cable (include both EU/UK plug)
- Users Manual
- Warranty card
- Fuse (4A)
- Pamphlet
- 7pin DIN plug
- 13pin DIN plug

6. SPECIFICATION

6-1.TS-990SE

General		
Frequency range (Transmitter)	160m band	1.81 ~ 2.0 MHz
	80m band	3.5 ~ 3.8 MHz
	40m band	7.0 ~ 7.2 MHz
	30m band	10.1 ~ 10.15 MHz
	20m band	14.0 ~ 14.35 MHz
	17m band	18.068 ~ 18.168 MHz
	15m band	21.0 ~ 21.45 MHz
	12m band	24.89 ~ 24.99 MHz
	10m band	28.0 ~ 29.7 MHz
	6m band	50.0 ~ 52.0 MHz
Frequency range (Receiver)		0.13 ~ 30 MHz, 50 ~ 54 MHz *1 VFO operation: 30 kHz ~ 60 MHz
Mode		A1A(CW), A3E(AM), J3E(SSB), F3E(FM), F1B(FSK), G1B(PSK)
Frequency stability		Within ± 0.1 ppm (0 °C ~ +50 °C)
Antenna impedance		50 Ω
Antenna tuner load range		16.7 ~ 150 Ω
Standard voltage		AC 220-240 V (50/60 Hz)
Supply voltage range		± 10 % (AC 198 V ~ 264 V)
Power consumption	At transmit (maximum)	840 VA or less
	At receive (no signal)	200 VA or less
Usable temperature range		0 °C ~ +50 °C
Dimensions	Without projection	W 460 x H 165 x D 400 mm
	Include projection	W 460 x H 182 x D 449 mm
	At front leg up position	H 201(front panel), H 173(rear panel)
Weight		Approx. 24.5 kg

Transmitter				
Output power	CW/SSB/FSK/PSK/FM (AM)	200 W (50 W)		
Modulation	SSB:Balanced, AM:Low Power, FM:Reactance			
Maximum frequency deviation (FM)	wide:Less than ± 5 kHz, narrow:Less than ± 2.5 kHz			
Spurious emissions	HF (Harmonics) : Less than -60 dB HF (others) : Less than -50 dB 50 MHz: Less than -66 dB			
Carrier suppression	Less than -60 dB			
Unwanted sideband suppression	Less than -60 dB			
Transmit frequency response	Within -6 dB (200 ~ 2700 Hz)			
Microphone impedance	600 Ω			
XIT variable range	± 9.999 kHz			
Receiver				
Circuit type		Main	Sub1 *2	Sub2 *3
		Double superheterodyne	Double superheterodyne	Triple superheterodyne
Intermediate frequency	1st IF	8.248 MHz	11.374 MHz	73.095 MHz
	2nd IF (FM)	24 kHz / (455 kHz)	24 kHz	10.695 MHz
	3rd IF (FM)	-	-	24 kHz / (455 kHz)
Sensitivity	SSB, CW, FSK, PSK (S/N 10 dB)	Less than 0.5 μ V (0.13 ~ 0.522 MHz) Less than 4 μ V (0.522 ~ 1.705 MHz) Less than 0.2 μ V (1.705 ~ 24.5 MHz) Less than 0.13 μ V (24.5 ~ 30 MHz) Less than 0.13 μ V (50 ~ 54 MHz)		
	AM (S/N 10 dB)	Less than 6.3 μ V (0.13 ~ 0.522 MHz) Less than 32 μ V (0.522 ~ 1.705 MHz) Less than 2 μ V (1.705 ~ 24.5 MHz) Less than 1.3 μ V (24.5 ~ 30 MHz) Less than 1.3 μ V (50 ~ 54 MHz)		
	FM (12 dB SINAD)	Less than 0.22 μ V (28 ~ 30 MHz) Less than 0.22 μ V (50 ~ 54 MHz)		
Image Rejection Ratio (50 MHz)		Less than 70 dB (60 dB)		
IF Rejection Ratio		Less than 70 dB		
Selectivity	SSB (LO:200 / HI:2800 Hz)	More than 2.4 kHz (-6 dB) Less than 4.4 kHz (60 dB)		
	CW, FSK, PSK (WIDTH:500 Hz)	More than 500 Hz (-6 dB) Less than 1.2 kHz (-60 dB)		
	AM (LO:100 / HI:3000 Hz)	More than 6.0 kHz (-6 dB) Less than 12 kHz (-50 dB)		
	FM	More than 12 kHz (-6 dB) Less than 25 kHz (-50 dB)		
RIT variable range		± 9.999 kHz		

Notch filter attenuation	More than 60 dB (Auto), More than 70 dB (Manual)
Beat cancel attenuation	More than 40 dB
Audio output	More than 1.5 (8Ω)
Audio output impedance	8 Ω

These specifications are guaranteed for Amateur Bands only.

60m band: UK only

**1 MAIN BAND: Spec. guaranteed in amateur band 160m through 6m*

**2 In 1.8/3.5/7/14/21 MHz Amateur band, IF band width 2.7 kHz or less (SSB, CW, FSK, PSK)*

**3 Except in above *2*

6-2.SP-990

General		SP-990 M
Size	Without projection Include projection (for front leg up position)	W 200 x H 165 x D 300 mm W 200 x H 182 x D 306 mm H 201(front panel), H 180(rear panel)
Weight		2.8 kg
Impedance		8 Ω ±15 %
High cut filter	HIGH1: HIGH2: HIGH1+2:	2.4 kHz / -3 dB 1.0 kHz / -3 dB 700 Hz / -3 dB
Low cut filter	LOW1: LOW2: LOW1+2:	200 Hz / -3 dB 400 Hz / -3 dB 600 Hz / -3 dB
Phone jack output	at 8 Ω	20 mW
Audio input	at 8 Ω	5 W
Line output impedance		1 kΩ